

Digitakt II

User Manual

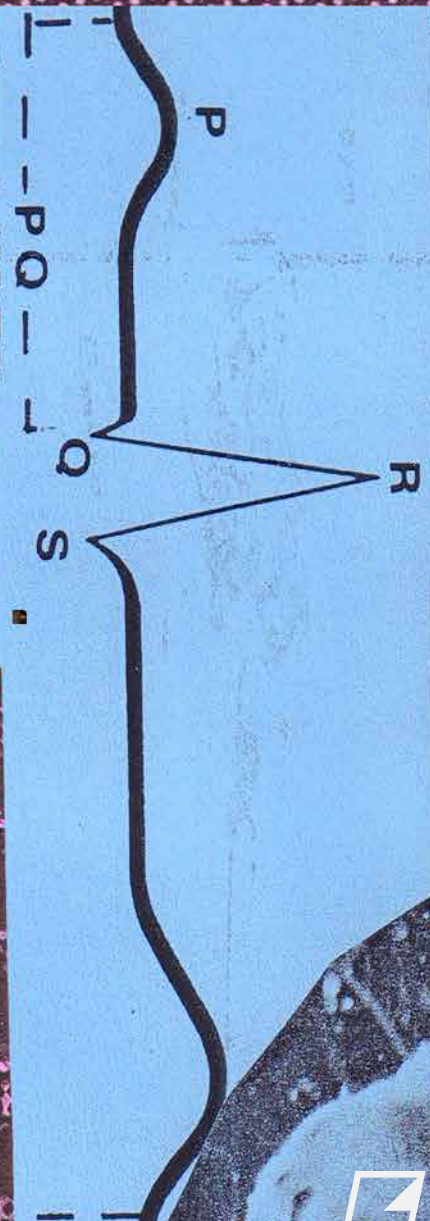
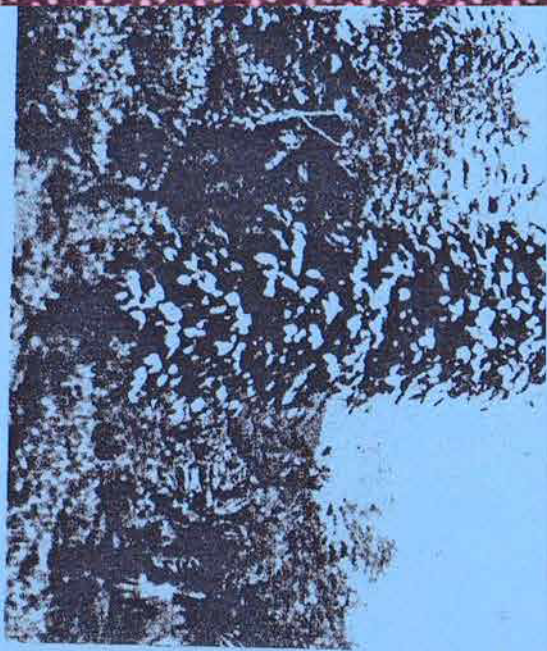

 **elektron**

FCC compliance statement

This device complies with part 15 of the FCC rules. Operation is subject to the following two conditions: (1) This device may not cause harmful interference, and (2) this device must accept any interference received, including interference that may cause undesired operation.

NOTE: This equipment has been tested and found to comply with the limits for a Class B digital device, pursuant to Part 15 of the FCC Rules. These limits are designed to provide reasonable protection against harmful interference in a residential installation. This equipment generates, uses and can radiate radio frequency energy and, if not installed and used in accordance with the instructions, may cause harmful interference to radio communications. However, there is no guarantee that interference will not occur in a particular installation. If this equipment does cause harmful interference to radio or television reception, which can be determined by turning the equipment off and on, the user is encouraged to try to correct the interference by one or more of the following measures:

- Reorient or relocate the receiving antenna.
- Increase the separation between the equipment and receiver.
- Connect the equipment into an outlet on a circuit different from that to which the receiver is connected.
- Consult the dealer or an experienced radio/TV technician for help.



WARNING: Cancer and Reproductive Harm – www.P65Warnings.ca.gov

AVERTISSEMENT: Cancer et effet nocif sur la reproduction – www.P65Warnings.ca.gov

ADVERTENCIA: Cáncer y Daño Reproductivo – www.P65Warnings.ca.gov

Canada

This Class B digital apparatus complies with Canadian ICES-003.
Cet appareil numérique de la classe B est conforme à la norme NMB-003.

European Union regulation compliance statement

This product has been tested to comply with the Low Voltage Directive 2014/35/EU and the Electro-magnetic Compatibility Directive 2014/30/EU. The product meets the requirements of RoHS 2 Directive 2011/65/EU.



This symbol indicates that your product must be disposed of properly according to local laws and regulations.

Legal disclaimer

The information in this document is subject to change without notice and should not be construed as a commitment by Elektron. Elektron assumes no responsibility for any errors that may appear in this document. Elektron may also make improvements and/or changes in the products and programs described in this document at any time without notice. In no event shall Elektron be liable for any special, indirect, or consequential damages or any damages whatsoever resulting from loss of use, data, or profits, whether in an action of contract, negligence, or other action, arising out of or in connection with the use or performance of this information.

IMPORTANT SAFETY AND MAINTENANCE INSTRUCTIONS

Please read these instructions carefully and adhere to the operating advice.

1. Do not use this unit near water.
2. Never use aggressive cleaners on the casing or on the screen. Remove dust, dirt and fingerprints with a soft, dry and non-abrasive cloth. More persistent dirt can be removed with a slightly damp cloth using only water. Disconnect all cables while doing this. Only reconnect them when the product is safely dry.
3. Install in accordance with the manufacturer's instructions. Make sure you place the unit on a stable surface before use. If you mount the unit in a rack, be sure to tighten all four screws in the rack mount holes.
4. Connect the unit to an easily accessible electrical outlet close to the unit.
5. When transporting the unit, use accessories recommended by the manufacturer or the original box and padding.
6. Do not install near any heat sources such as radiators, heat registers, stoves, or any other equipment (including amplifiers) producing heat.
7. Do not put the PL-2S Protective Cover (Elektron accessory) on the unit while the unit is powered on.
8. This product, by itself or in combination with amplifiers, headphones or speakers, is capable of producing sound levels that may cause permanent hearing loss. Do not operate at a high volume level or at a level that is uncomfortable.
9. Protect the power cord from being walked on or pinched particularly at plugs, convenience receptacles, and the point where they exit from the unit.
10. Only use attachments/accessories specified by the manufacturer.
11. Unplug this unit during lightning storms or when it is not used for long periods of time.
12. Refer all servicing to qualified service technicians. Servicing is required when the unit has been damaged in any way, liquid has been spilled or objects have fallen into the unit, the unit has been exposed to rain or moisture, does not operate normally, or has been dropped.

WARNING

To reduce the risk of fire, electrical shock or product damage:

- Do not expose the unit to rain, moisture, dripping or splashing and also avoid placing objects filled with liquid, such as vases, on the unit.
- Do not expose the unit to direct sunlight, nor use it in ambient temperatures exceeding 40°C as this can lead to malfunction.
- Do not open the casing. There are no user repairable or adjustable parts inside. Leave service and repairs to trained service technicians only.
- Do not exceed the limitations specified in the Electrical specifications.

SAFETY INSTRUCTIONS FOR THE POWER ADAPTER

- The adapter is not safety grounded and may only be used indoors.
- To ensure good ventilation for the adapter, do not place it in tight spaces. To prevent risk of electric shock and fire because of overheating, ensure that curtains and other objects do not prevent adapter ventilation.
- Do not expose the power adapter to direct sunlight, nor use it in ambient temperatures exceeding 40°C.
- Connect the adapter to an easily accessible electrical outlet close to the unit.
- The adapter is in standby mode when the power cord is connected. The primary circuit is always active when the cord is connected to the power outlet. Pull out the cord to completely disconnect the adapter.
- In the EU, only use CE approved power cords.

RESTART

- For a complete restart of the Digitakt II, wait for at least 30 seconds after turning it off before turning it on again.

TABLE OF CONTENTS

1. INTRODUCTION	10
1.1 CONVENTIONS IN THIS MANUAL.....	10
2. THE DIGITAKT II	11
3. PANEL LAYOUT AND CONNECTORS	12
3.1 FRONT PANEL	12
3.2 REAR CONNECTORS.....	14
3.3 SETTING UP AND STARTING THE DIGITAKT II	14
4. DIGITAKT II SOUND ARCHITECTURE	15
4.1 AUDIO VOICES	15
4.2 EFFECTS	15
5. OVERVIEW OF THE DIGITAKT II DATA STRUCTURE	16
5.1 +DRIVE	16
5.2 DATA STRUCTURE	16
5.2.1 PROJECT	16
5.2.2 SONGS	16
5.2.3 PATTERNS	16
5.2.4 KIT	16
5.2.5 PRESETS.....	16
5.2.6 SAMPLES	17
5.3 ABOUT THE TRACKS	17
5.3.1 AUDIO TRACKS AND MACHINES	17
5.3.2 MIDI TRACKS.....	17
5.3.3 EDITING THE TRACKS.....	17
6. INTERACTING WITH THE DIGITAKT II	18
6.1 SCREEN NAVIGATION	18
6.2 PARAMETER EDITING	18
6.2.1 PARAMETER VALUE JUMP	19
6.2.2 CONTROL ALL	19
6.2.3 [FUNC] KEY PRESS COMBINATIONS	19
6.3 QUICK SCROLLING	19
6.4 COPY, CLEAR, AND PASTE	19
6.5 THE NAMING SCREEN	19
6.5.1 POP-UP NAMING.....	19
6.6 OVERBRIDGE.....	20
6.7 CLASS COMPLIANT DEVICE	20
6.8 BACKING UP THE DIGITAKT II.....	20
6.8.1 BACKING UP PROJECTS, PRESETS AND SAMPLES.....	20
6.8.2 TRANSFERRING BACKED UP FILES TO YOUR ELEKTRON DEVICE	21
7. QUICK START	22
7.1 PLAYING THE FACTORY PRESETS	22
7.1.1 USING KEYBOARD MODE.....	22
7.1.2 USING MUTE MODE.....	22
7.1.3 TEMPO AND METRONOME	22
7.1.4 EDITING PARAMETERS.....	23
7.2 SAMPLING FROM THE EXTERNAL INPUTS.....	23
8. DIGITAKT II CONTROLS	25

8.1 TRIG KEYS	25
8.2 ROTARY ENCODERS	25
8.3 KEY BEHAVIOR	25
8.4 MIDI NOTES	25
8.5 MODES	25
8.5.1 KEYBOARD MODE	25
8.5.2 KEYBOARD SETUP MENU	25
8.5.3 MUTE MODE	26
8.5.4 TRIG MODE	27
9. PATTERNS, KITS, PRESETS, AND SAMPLES	29
9.1 THE +DRIVE LIBRARY AND THE POOL	29
9.1.1 ADDING PRESETS TO THE POOL	29
9.2 PRESET BROWSER	30
9.3 PRESET/KIT MENU	30
9.3.1 LOAD (PRESET)	30
9.3.2 SAVE (PRESET)	31
9.3.3 MANAGE (PRESET)	31
9.3.4 POOL	33
9.3.5 LOAD (KIT)	33
9.3.6 SAVE (KIT)	34
9.3.7 MANAGE (KIT)	34
9.4 PLAYING A PRESET	35
9.5 EDITING A PRESET	35
9.6 SAVING A PRESET	35
9.7 ASSIGNING A SAMPLE	36
9.7.1 ASSIGNING A SAMPLE USING THE QUICK ASSIGN METHOD	36
9.8 THE SETUP MENU	36
9.8.1 KIT	37
9.8.2 TRACK	37
10. THE SEQUENCER	40
10.1 PATTERN OPERATIONS	40
10.1.1 SELECTING BANK AND PATTERN	40
10.1.2 PATTERN CONTROL	40
10.1.3 CHAINS	40
10.2 EDITING A PATTERN	41
10.2.1 TRIG TYPES	41
10.2.2 GRID RECORDING MODE	42
10.2.3 LIVE RECORDING MODE	42
10.2.4 STEP RECORDING MODE	43
10.3 SEQUENCER MENU (EUCLIDEAN MODE)	44
10.4 MICRO TIMING	45
10.5 RETRIGS	45
10.6 QUANTIZE MENU	45
10.7 PAGE SETUP MENU	45
10.7.1 PER PATTERN MODE	45
10.7.2 PER TRACK MODE	46
10.8 SEQUENCER FEATURES	47
10.8.1 PARAMETER LOCKS	47
10.8.2 PRESET LOCKS	47
10.7.3 TRIG CONDITIONS AND CONDITIONAL LOCKS	48
10.8.4 FILL MODE	49

TABLE OF CONTENTS

10.8.5 COPY, PASTE AND CLEAR OPERATIONS	49
10.8.6 TEMPORARY SAVE AND RELOAD PATTERN COMMANDS	49
10.9 SONG MODE	50
10.9.1 THE SONG EDIT SCREEN	50
10.9.2 CREATING AND EDITING A SONG.....	51
10.9.3 PLAYING A SONG	51
10.10 PERFORM KIT MODE.....	52
10.10.1 PERFORM KIT MODE ACTIONS.....	52
11. TRACK PARAMETERS	53
11.1 EDITING THE TRACK PARAMETERS.....	53
11.2 TRIG PAGE 1	53
11.3 TRIG PAGE 2	54
11.4 SRC PAGE	55
11.5 FLTR PAGE 1	55
11.6 FLTR PAGE 2	55
11.7 AMP PAGE	56
11.8 FX PAGE	57
11.9 MOD PAGE 1.....	58
11.10 MOD PAGE 2	59
11.11 MOD PAGE 3	59
12. FX AND MIXER PARAMETERS	61
12.1 EDITING THE SEND FX AND MIXER PARAMETERS	61
12.2 DELAY.....	61
12.3 REVERB	62
12.4 CHORUS.....	63
12.5 COMPRESSOR.....	63
12.6 INTERNAL MIXER PAGE 1.....	65
12.7 INTERNAL MIXER PAGE 2	65
12.8 FX MIXER.....	65
12.9 EXTERNAL MIXER	66
13. SAMPLING	68
13.1 SAMPLING MENU.....	68
13.1.1 SRC	68
13.1.2 RECORD NOW	68
13.1.3 THRES.....	68
13.1.4 MON.....	68
13.1.5 R.LEN.....	68
13.1.6 R.STRT.....	69
13.1.7 ARM	69
13.2 SAMPLING AUDIO.....	69
13.3 ASSIGNING A SAMPLE TO A TRACK FROM THE +DRIVE	69
13.4 SAMPLE PLAYBACK	70
13.6 SAMPLES MENU	70
13.6.1 LOADING A SAMPLE	71
13.6.2 UNLOADING A SAMPLE.....	72
13.6.3 REPLACING A SAMPLE.....	72
13.6.4 RENAMING A SAMPLE.....	72
13.6.5 MOVING A SAMPLE.....	72
13.6.6 REMOVING UNUSED SAMPLES FROM RAM	73
13.6.7 TRANSFERRING SAMPLES FROM A COMPUTER TO DIGITAKT II.....	73

13.6.8 CREATING A NEW DESTINATION DIRECTORY	73
13.6.9 TRANSFERRING SAMPLES FROM DIGITAKT II TO A COMPUTER	73
14. SETTINGS MENU	74
14.1 PROJECT	74
14.1.1 LOAD PROJECT	74
14.1.2 SAVE PROJECT AS	74
14.1.3 MANAGE PROJECTS	74
14.2 SONG	75
14.2.1 RENAME	75
14.2.2 CLEAR	75
14.2.3 LOAD	75
14.2.4 SAVE TO PROJ	75
14.3 PATTERN MENU	75
14.3.1 RENAME	75
14.3.2 CLEAR	75
14.3.3 SAVE TO PROJ	75
14.3.4 RELOAD FROM PROJ	76
14.4 MIDI CONFIG	76
14.4.1 SYNC	76
14.4.2 PORT CONFIG	76
14.4.3 CHANNELS	78
14.5 SYSEX DUMP	78
14.5.1 SYSEX SEND	78
14.5.2 SYSEX RECEIVE	79
14.6 AUDIO ROUTING	79
14.6.1 TO MAIN	79
14.6.2 TO FX	80
14.6.3 USB IN	80
14.6.4 USB OUT	80
14.6.5 INT TO MAIN	80
14.6.6 USB TO MAIN [dB]	80
14.6.7 PRE/POST FADER	80
14.7 PERSONALIZE	80
14.7.1 LED INTENSITY	81
14.7.2 LED BACKLIGHT	81
14.7.3 REMEMBER SUBPAGE	81
14.7.4 U/D KEY MODE	81
14.7.5 PAGE AUTOCOPY	81
14.8 SYSTEM	81
14.8.1 USB CONFIG	81
14.8.2 OS UPGRADE	82
14.8.3 FORMAT +DRIVE	82
14.8.4 STORAGE	82
15. STARTUP MENU	83
15.1 TEST MODE	83
15.2 EMPTY RESET	83
15.3 FACTORY RESET	83
15.4 OS UPGRADE	83
15.5 EXIT	83
16. SETUP EXAMPLES	84
16.1 DIGITAKT II WITH A MONOPHONIC BASS MACHINE	84

16.2 DIGITAKT II WITH A SMART PHONE	84
16.3 CONTROLLING A SYNTHESIZER USING THE MIDI TRACKS	85
17. KEY COMBINATIONS	86
18. TECHNICAL INFORMATION.....	89
19. CREDITS AND CONTACT INFORMATION.....	90
APPENDIX A: MACHINES	91
A.1 ASSIGNING MACHINES TO THE ACTIVE TRACK.....	91
A.2 SRC MACHINES	91
A.2.1 ONESHOT	91
A.2.2 WERP.....	92
A.2.3 STRETCH.....	94
A.2.4 REPITCH.....	94
A.2.5 GRID.....	95
A.2.6 MIDI	97
A.3 FLTR MACHINES.....	100
A.3.1 MULTI-MODE.....	100
A.3.2 LOWPASS 4	100
A.3.3 EQ	101
A.3.4 COMB.....	102
A.3.5 LEGACY.....	102
APPENDIX B: MIDI	104
B.1 TRACK PARAMETERS.....	104
B.2 TRIG PARAMETERS	104
B.3 SOURCE PARAMETERS.....	104
B.4 FILTER PARAMETERS	104
B.5 AMP PARAMETERS.....	105
B.6 EUCLIDEAN SEQUENCER PARAMETERS	105
B.7 FX PARAMETERS.....	105
B.8 MOD PARAMETERS	105
B.9 SEND FX PARAMETERS	106
B.10 MIXER PARAMETERS.....	107
B.8 VAL PARAMETERS	108
B.9 MISC PARAMETERS	108
APPENDIX C: LFO MODULATION DESTINATIONS.....	109
APPENDIX D: KEYBOARD SCALES.....	110
INDEX.....	111

1. INTRODUCTION

The Digitakt II is a compact drum machine and sampler from Elektron. It contains all the necessary tools to create music and make people move to the beat. A highly flexible sound engine with several different sample playback machines, stereo sampling capability, a live-friendly sequencer, and extensive possibilities to control external MIDI gear. To get the most out of your Digitakt II, we recommend that you read this manual in its entirety.

1.1 CONVENTIONS IN THIS MANUAL

We have used the following conventions throughout the manual:

Key names are written in upper case, bold style and within brackets. For instance, the key labeled “FUNC” on the main panel is written as **[FUNC]**.

Knobs are written in upper case, bold, italic letters. For instance, the knob “Level/Data” is called ***LEVEL/ DATA***.

Menu names are written in upper case letters. The SETTINGS menu is an example of that.

Parameter names and certain menu options where settings can be made or actions performed are written in bold, upper case letters. For example, **VOL**.

Upper case letters are used for parameter setting alternatives. For example, **OFF**.

Messages visible on the screen are written in upper case letters with quotation marks. For example, “QUANTIZE LIVE REC”.

LED indicators like the Page LEDs are written like this: <PAGE>.

The following symbols are used throughout the manual:



Important information that you should pay attention to.



A tip that will make it easier for you to interact with the Digitakt II.



The Stereo-sausage butterfly.

2. THE DIGITAKT II

Welcome to Digitakt II. The Digitakt experience, but multiplied. A whole new dimension, in fact. Resetting the boundaries that its predecessor pushed. Idea after idea, OS after OS, the original Digitakt went from strength to strength, until finally reaching its brim. This next chapter is about what's beyond the brim.

Digitakt II emerged as its own beast, pushing what's possible beyond the horizon. This is a box that offers an immeasurable collage of possibilities: 16 tracks that can be either audio or MIDI tracks, stereo sampling, a 128 step sequencer, and oodles extra power and memory letting you do more than ever. And then there's a more modular workflow, swappable filters, additional sequencer mode, and kits and trig modes, all giving you a more customizable creative experience.

So, now, for you with all of the above at your fingertips, it is time to take your place in this beginning. The start line beckons. Flick the switch and set off on your own sonic adventures. Who knows what the destination will be? We can only guarantee that the journey is going to be a fun-filled blast.

Sincerely,

The Elektron Team

3. PANEL LAYOUT AND CONNECTORS

3.1 FRONT PANEL

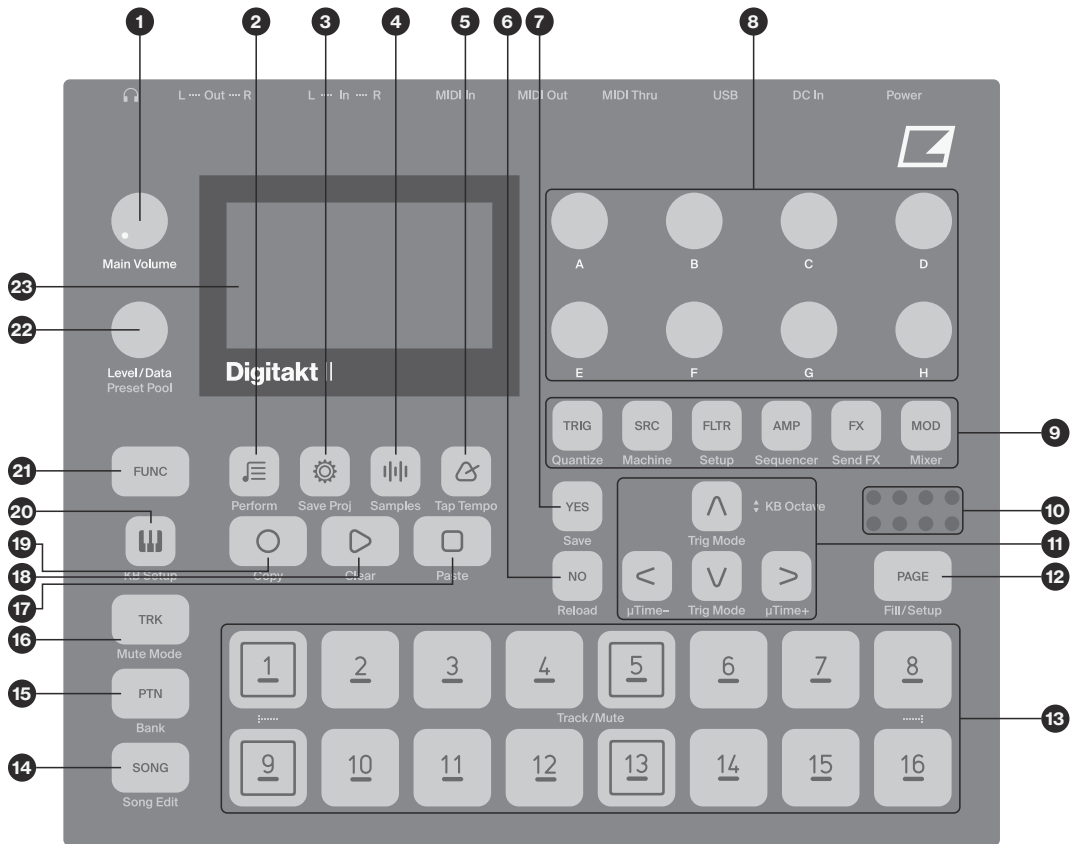

1. **MAIN VOLUME** sets the volume for the main outputs and the headphones output.
2. **[PRESET/KIT]** opens PRESET/KIT menu where you manage the presets and kits. The secondary function accesses the PERFORM KIT mode.
3. **[SETTINGS]** contains the management of projects, MIDI configuration, and the System settings. The secondary function saves the current project.
4. **[SAMPLING]** opens the SAMPLING menu, where you perform the sampling. The secondary function opens the SAMPLES menu.
5. **[TEMPO]** opens the TEMPO menu, where you can adjust the global/pattern tempo and also adjust the swing. Here you also find the settings for the metronome. The secondary function makes it possible to tap the tempo.
6. **[NO]** key. Used for exiting an active menu, backing one step and negating. The secondary function is to temporarily reload the active pattern.
7. **[YES]** key. Used for entering sub-menus, selecting and confirming. The secondary function is to temporarily save the active pattern.
8. **DATA ENTRY** knobs **A-H**. Used for setting parameter values. Press and turn the knobs to change values in larger increments.
9. **[PARAMETER]** keys access the PARAMETER pages of the active track. The color of the keys indicates if the page is active (red/orange) or inactive (off).
 - **[TRIG PARAMETERS]** accesses parameters such as **NOTE**, **VELOCITY**, and other trig related parameters. The secondary function accesses the QUANTIZE menu.
 - **[SRC]** takes you to the SOURCE page that has the parameters for the selected SRC machine on audio tracks. For MIDI tracks this page has parameters such as **CHANNEL**, **PROGRAM**, and **AFTERTOUCH**. The secondary function accesses the MACHINE menu.

- **[FLTR]** accesses the FILTER page. Here are the parameters for the FLTR machine for the audio tracks. On MIDI tracks you find the CC value settings and CC select settings for track 1–8 here. The secondary function accesses the SETUP menu.
 - **[AMP]** takes you to the AMP page, where you find parameters for the amplitude envelope and effect sends. On MIDI tracks you find the CC value settings and CC select settings for track 9–16 here. The secondary function accesses the SEQUENCER menu where you find the parameters for the euclidean sequencer.
 - **[FX]** takes you to the FX pages, where you find parameters for the bit reduction, overdrive, sample rate reduction, and effect sends levels. The secondary page accesses the parameters for the send effects.
 - **[MOD]** accesses the LFO parameters for the active track. The secondary function accesses the MIXER pages.
10. The <PATTERN PAGE> LEDs indicate how many pattern pages the active pattern consists of and which pattern page is currently active. The LED flashes on the pattern page currently playing.
 11. The **[ARROW]** keys. Used for navigation and for setting some parameter values. Separately, they are called **[UP]**, **[DOWN]**, **[LEFT]**, and **[RIGHT]**.
 12. **[PAGE]** selects the active pattern page, The secondary function accesses the PAGE SETUP menu. This key also activates FILL mode.
 13. **[TRIG]** keys are used for entering or removing sequencer trigs, and parameter locks, in combination with the **DATA ENTRY** knobs. They are also used to select a track, bank, pattern, and song in combination with the **[TRK]**, **[PTN]**, and **[SONG]** keys. The **[TRIG]** keys are also used as a keyboard in KEYBOARD mode. The secondary function is to Quick Mute tracks.
The **[TRIG]** keys lights indicate trigs on the sequencer by lit red keys, while flashing red or yellow keys indicates parameter locks, in GRID RECORDING and STEP RECORDING mode. When a pattern is playing, or when LIVE RECORDING is enabled, a light “runs” along the 16 steps of the sequencer across all (up to eight) pages at the set tempo.
 14. **[SONG]** selects song 1–16 in combination with the **[TRIG 1–16]** keys. The secondary function accesses the Song edit screen.
 15. **[PTN]** selects the bank and pattern in combination with the **[LEFT]/[RIGHT]** and **[TRIG 1–16]** keys. The secondary function opens the Bank selection.
 16. **[TRK]** key. Press **[TRK]** + one of the **[TRIG]** keys to select a track for editing. The secondary function accesses the MUTE mode.
 17. **[STOP]** stops playback. The secondary function is the paste operation.
 18. **[PLAY]** starts the sequencer playback. Pressing **[PLAY]** a second time pauses playback. The secondary function is the clear operation.
 19. **[RECORD]** key. Activates/deactivates GRID RECORDING mode. Press **[RECORD]** + **[PLAY]**, to activate LIVE RECORDING mode. Press **[RECORD]** + **[STOP]**, to activate STEP RECORDING mode. The secondary function is the copy operation.
 20. **[KEYBOARD]** toggles KEYBOARD mode on/off. The secondary function opens the KEYBOARD SETUP menu where you can view and edit settings such as scale, root note, and keyboard fold..
 21. **[FUNC]** key. Press, hold and press another key to access the secondary function of that key. The secondary functions are written in orange on the Digitakt II front panel.
 22. **LEVEL/DATA** sets the overall volume level of the active track. It is also used for setting parameters and scrolling through lists. The secondary function opens the PRESET MANAGER. This knob is also used to open the PRESET POOL when adding preset locks.
 23. Screen.

3.2 REAR CONNECTORS

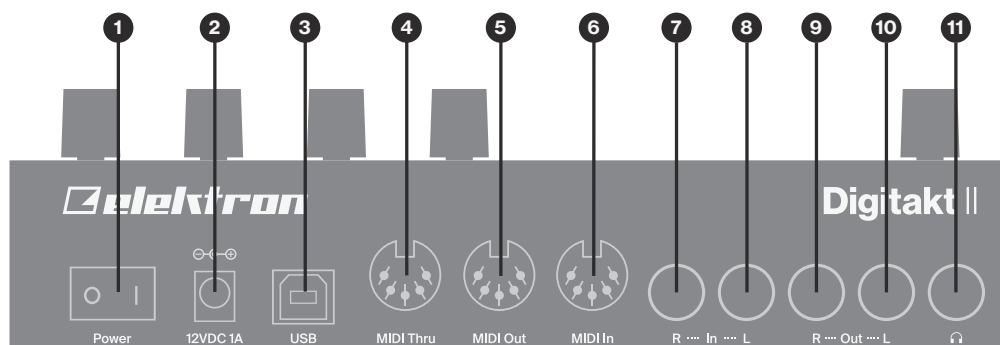

1. **POWER**, Switch for turning the unit on and off.
2. **DC In**, Input for power supply. Use the included PSU-3c power adapter, connected to a power outlet.
3. **USB**, For connecting the unit to a computer and for MIDI-control. Use the included A to B USB 2.0 connector cable to connect to a computer host.
4. **MIDI THRU/SYNC B**, Forwards data from MIDI IN. Can also be configured to send DIN sync to legacy instruments. Use a standard MIDI cable to connect another MIDI device in the chain.
5. **MIDI OUT/SYNC A**, MIDI data output. Can also be configured to send DIN sync to legacy instruments. Use a standard MIDI cable to connect to MIDI In of an external MIDI device.
6. **MIDI IN**, MIDI data input. Use a standard MIDI cable to connect to MIDI Out of an external MIDI device.
7. **IN L/R**, Audio inputs used for external sources for sampling or audio processing. Use either a 1/4" (Tip/Ring/Sleeve) phone plug (balanced connection) or a 1/4" mono phone plug (unbalanced connection).
8. **OUT L/R**, Main audio outputs. Use either a 1/4" (Tip/Ring/Sleeve) phone plug (balanced connection) or a 1/4" mono phone plug (unbalanced connection).
9. **HEADPHONES**, Audio output for stereo headphones. Use 1/4" (Tip/Ring/Sleeve) phone plug.

3.3 SETTING UP AND STARTING THE DIGITAKT II

Make sure you place the Digitakt II on a stable support, such as a sturdy table, with sufficient space for the cables. Make sure to switch off all devices before you connect the Digitakt II to other devices.

1. Plug the supplied DC adapter to a power outlet and connect the small plug to the 12 V DC In on the Digitakt II.
2. Connect OUT L/R from the Digitakt II to your mixer or amplifier.
3. To control the Digitakt II from a computer, connect a USB cable between the computer and the USB connector of the Digitakt II.
4. If you want to use MIDI to control the Digitakt II, connect the MIDI OUT port of the device you wish to send data from to the MIDI IN port of the Digitakt II. The MIDI THRU port duplicates the data arriving at the MIDI IN port, so it can be used for chaining MIDI units together. Connect the MIDI OUT port of the Digitakt II to the MIDI IN port of the of the device you want to control if you want to use Digitakt II to control other devices using MIDI.
5. If you want to sample or process audio from external sources, connect the audio source to IN L/R or via USB (sampling only).
6. Switch on all units. Switch on the Digitakt II by pressing the Power switch located at the back of the unit.

4. DIGITAKT II SOUND ARCHITECTURE

The illustrations below show the Digitakt II sound architecture, with its 16 stereo audio voices, three send effects (chorus, delay and reverb), and master effects (compressor, master overdrive).

4.1 AUDIO VOICES

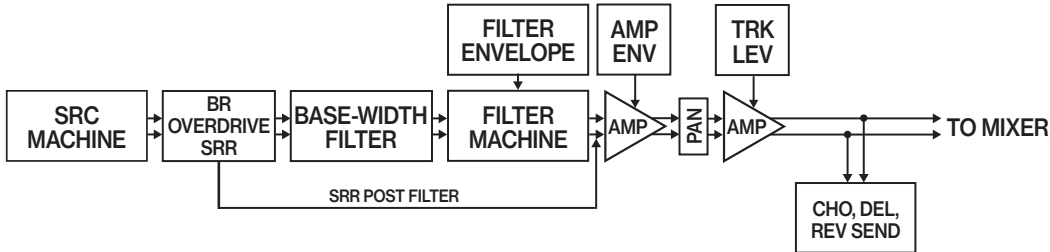

4.2 EFFECTS

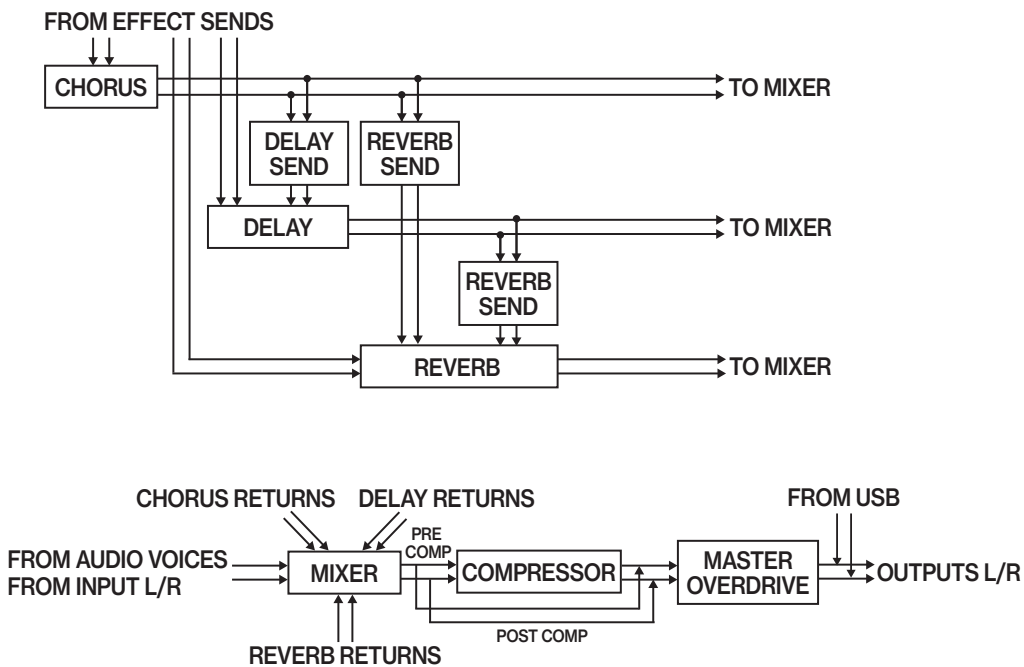

5. OVERVIEW OF THE DIGITAKT II DATA STRUCTURE

The image below outlines the data structure of the Digitakt II.

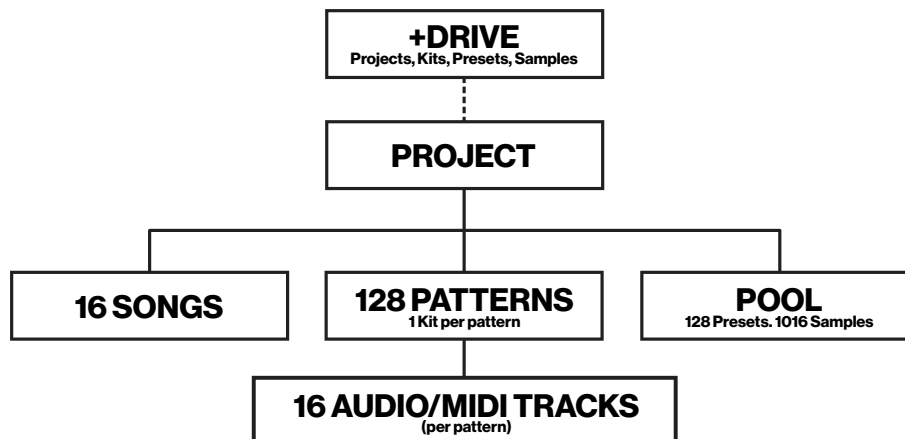

5.1 +DRIVE

The +Drive is a non-volatile storage. It keeps up to 128 projects and 1024 kits stored internally, and it also holds all saved presets. The +Drive also contains the sample bank that can hold up to 20 GB of user samples. All projects have access to these samples.

5.2 DATA STRUCTURE

5.2.1 PROJECT

A project contains up to 128 patterns. General settings and states are also stored in the project. When a project is loaded it becomes the active working state of the Digitakt II. From here it is possible to edit the patterns and presets of the project. Every time the Digitakt II is switched on, it boots to the active working state, the active project. Projects are saved, loaded and managed in the SETTINGS menu. For more information, please see "14.1 PROJECT" on page 74.

5.2.2 SONGS

A song is an arrangement of patterns set up to play in sequence. Each row in the SONG mode arrangement can have separate settings for pattern, row repeat, row length, tempo, and mute. A song can be up to 99 rows in length, and each project can contain up to 16 songs. For more information, please see "10.9 SONG MODE" on page 50.

5.2.3 PATTERNS

The patterns are the primary data container for the Digitakt II. 16 patterns are available for each of the eight banks, which means that 128 patterns are available for each project. A pattern contains up to 16 presets (one for each audio track), a kit, and sequencer data like trigs and parameter locks for the 16 tracks.. It also contains the settings on the TRIG page and BPM, length, swing and time signature settings. For more information, please see "10. THE SEQUENCER" on page 40.

5.2.4 KIT

A kit is a collection of 16 presets, one for every track in a pattern. For more information, please see "9.3 PRESET/KIT MENU" on page 30, "9. PATTERNS, KITS, PRESETS, AND SAMPLES" on page 29, and "11. TRACK PARAMETERS" on page 53.

5.2.5 PRESETS

A preset is a sample (for audio track presets), plus all the track settings in the SRC, FLTR, AMP, FX, and MOD parameter pages. Or, in the case of MIDI presets, the SRC, FLTR, AMP, and MOD PARAMETER pages settings.. Presets are stored in the +Drive library. The +Drive library holds up to 2048 presets. You can use the PRESET MANAGER to manage presets. For more information, please see "9.3 PRESET/KIT MENU" on page 30, "9. PATTERNS, KITS, PRESETS, AND SAMPLES" on page 29, and "11. TRACK PARAMETERS" on page 53.



It is also possible to save/load/manage MIDI track presets in the same way as you do with audio track presets.



When a preset or kit is imported to a pattern, it becomes an independent copy of the preset/kit on the +Drive and is not linked to the original preset/kit on the +Drive. Instead, it fully becomes a part of the pattern.

5.2.6 SAMPLES

You can load up to 400 MB (about 72 minutes in mono, 36 minutes in stereo) of samples in a project, using a maximum of 1016 sample slots. Samples are stored in the +Drive Sample bank. Additional samples can be transferred to the Digitakt II from a computer with the Elektron Transfer software. You also have the possibility to sample straight into the Digitakt II. For more information, please see "13. SAMPLING" on page 68.

5.3 ABOUT THE TRACKS

The Digitakt II sequencer has 16 tracks that can be either an audio track or a MIDI track.

5.3.1 AUDIO TRACKS AND MACHINES

Any of the sixteen tracks can be used as an audio track. This is the default track setting. Each audio track contains one sample, and the parameter settings in the PARAMETER pages TRIG, SRC, FLTR, FX, AMP, and MOD. A track that contains any other SRC machine than the MIDI machine is considered an audio track.

A machine is a module within the Digitakt II with specific functionality. A machine can be switched out for another machine in the same category. For example different sample playback engines or a selection of filters. Every machine has a specific set of parameters tailored to give you the most relevant and useful sound-shaping possibilities for that particular machine. For more information, please see "APPENDIX A: MACHINES" on page 91.

5.3.2 MIDI TRACKS

Any of the 16 tracks can be used as a MIDI track. They are used to control external, MIDI equipped, gear. Each MIDI track can trigger a chord of up to four notes with adjustable parameters such as velocity and length, control pitch bend and aftertouch, as well as sixteen freely assignable MIDI control change parameters (MIDI CCs). For more information, please see "A.2.6 MIDI" on page 97. Any MIDI channel can be assigned to a MIDI track and several tracks can share the same channel. If several tracks are assigned to the same MIDI channel the track with the lowest number has priority in case of parameter conflicts.

The MIDI tracks function almost the same way as the audio tracks. Parameter locks, LFO modulation, copy and paste commands are available. Each MIDI track also features micro timing, individual track length and time signature settings. The main difference is that the MIDI tracks do not generate any sound and the sequencer data is instead transmitted through the MIDI OUT or USB ports.

To use a track as a MIDI track, you must first assign a MIDI machine to it.

1. Press **[FUNC] + [SRC]** to open the MACHINE menu.
2. Use **[LEFT]/[RIGHT]** to navigate to the SRC machine category.
3. Use **[UP]/[DOWN]** to select the MIDI machine, and then press **[YES]** to assign it to the track.

5.3.3 EDITING THE TRACKS

The six **[PARAMETER]** keys open parameter pages that are used for editing the tracks.

- The TRIG page contains different parameters such as **NOTE**, **VELOCITY**, and other trig related parameters.
- The SRC page hosts the parameters that deal with machine specific functionality.
- On the FLTR page, you find parameters for the selected filter/EQ machine and the base-width filter on audio tracks. On MIDI tracks you find the CC value settings and the CC select settings for CC parameters 1–8 here.
- The AMP page for audio tracks hosts parameters for the amplitude envelope. On MIDI tracks you find the CC value settings and the CC select settings for CC parameters 9–16 here.
- The FX page contains the Bit Reduction, Overdrive, Sample Rate Reduction, and the send effects send levels for audio tracks, The FX page is empty for MIDI tracks.
- The MOD page hosts LFO parameters for the active track.

Use the DATA ENTRY knobs A-H to edit the corresponding parameters. Press and turn a knob to adjust its parameter in larger increments. Press and hold a **[PARAMETER]** key to see the values for all parameters on that page. For more information, please see "11. TRACK PARAMETERS" on page 53, and "A.2.6 MIDI" on page 97.

6. INTERACTING WITH THE DIGITAKT II

The screen shows all the information needed for real-time interaction and editing on the Digitakt II. The eight **DATA ENTRY** knob parameters shown will vary depending on the given situation. Below is the main interface screen of the SRC page.

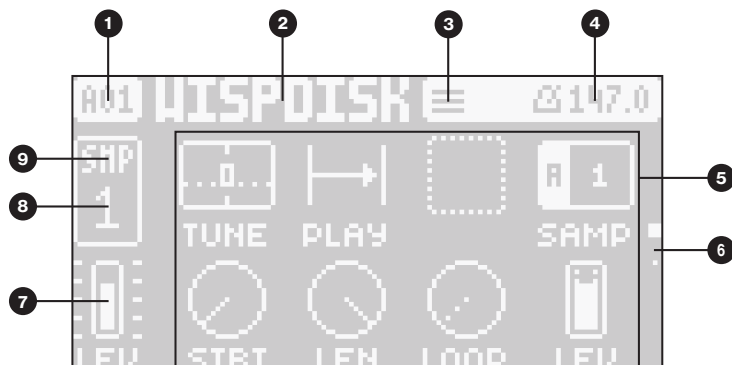

1. The current bank and pattern.
2. The current pattern name.
3. The selected TRIG mode.
4. The current tempo.
5. Eight track parameters. They show what the **DATA ENTRY** knobs control and their current parameter values.
6. Parameter page indicator. Indicates the number of pages for the selected parameter section and which page is currently selected.
7. The main level setting of the active track. Use the **LEVEL/DATA** knob to change the volume setting.
8. The current active track.
9. Track type. Audio (SMP) track or MIDI (MID) track.



The Digitakt II features a screen saver that dims the screen after 5 minutes of inactivity and turns off the screen after 60 minutes. Press any key or move any controller to wake the screen.

6.1 SCREEN NAVIGATION

Use the [ARROW] keys [UP], [DOWN], [LEFT] or [RIGHT] to navigate menus or sub-menus. The **LEVEL/DATA** knob can be used to scroll through menus and lists quickly.

[YES] is used to affirm, select, enter sub-menus and tick/untick boxes.

[NO] is used to negate, deselect or go back one or more steps.



When in a menu or sub-menu, the [NO] key can be used to go back, one step at a time, all the way to the main screen.

6.2 PARAMETER EDITING

The **DATA ENTRY** knobs are used to change the values of the track parameters. The positions of the parameters on the screen correspond to the physical locations of the knobs on the front panel. Some of the parameters on the screen tell you what **DATA ENTRY** knob controls that particular parameter. For example "(E)" in the PAGE SETUP menu.

- The parameters are adjusted in larger increments if you press down the **DATA ENTRY** knob while turning it. This makes it quicker to sweep through the whole parameter range.
- Press **DATA ENTRY** knob + [NO] to reset the parameter to the default value.
- Press [PARAMETER] key + [PLAY] to reset all the parameters in the selected parameter page to default values.
- Press and hold a [PARAMETER] key to see the values for all parameters on that page.

6.2.1 PARAMETER VALUE JUMP

Pressing [FUNC] while editing certain parameters will make the parameter values jump to appropriate positions. The NOTE parameter, for example jumps between octaves and the delay time jumps between BPM related tempo settings.

6.2.2 CONTROL ALL

If you press and hold [TRK] and change a parameter setting, this change will affect this parameter in all the audio tracks in the pattern. Press [NO] before you release [TRK] to revert the parameter changes. In the SETUP menu, you have the possibility to select which tracks should be affected by the control all functionality. For more information, please see "9.8.1 KIT" on page 37.



The control all functionality is not available for the MIDI tracks.

6.2.3 [FUNC] KEY PRESS COMBINATIONS

The standard way to use the [FUNC] key in combination with other keys, is to press and hold [FUNC] and then make a short press on the second key in the combination.

6.3 QUICK SCROLLING

Scroll through menus using the *LEVEL/DATA* knob. Quick scrolling is possible on many menus. Press [FUNC] + the [UP] or [DOWN] keys to move the cursor one menu page.

6.4 COPY, CLEAR, AND PASTE

Copy, clear and paste commands are available in a lot of contexts. Pressing [FUNC] + [RECORD] to copy. Press [FUNC] + [STOP] to paste. Press [FUNC] + [PLAY] to clear. Paste and clear operations are undone by repeating the key press combination. Please see the different sections in the manual for more information on when these commands are available. For more information, please see "17. KEY COMBINATIONS" on page 86.



The copy clipboard can only hold one item at a time. When you perform a copy command, the item copied replaces any earlier copied items. For example, you can not have both a trig and a pattern copied at the same time.

6.5 THE NAMING SCREEN

The naming method is identical for the various naming situations that appear when you save samples, presets, projects et cetera.



The [LEFT] and [RIGHT] arrow keys are used to navigate between the characters. Turning the *LEVEL/DATA* knob or pressing the [UP] or [DOWN] arrow keys selects the characters. [FUNC] + [NO] erases characters. [FUNC] + [YES] inserts space. Press [SETTINGS] to create a random name. Press and hold [FUNC] to access the Pop-up Naming menu.

6.5.1 POP-UP NAMING

A convenient way of naming is to open a pop-up menu that shows all available letters, symbols, and digits. Press and hold the [FUNC] key when you are on the NAMING screen to access the Pop-up Naming screen.



Keep [FUNC] pressed and use the [ARROW] keys to highlight the character you want to insert. Once there, release [FUNC] to add the character.



Copy, paste, and clear commands are available on the NAMING screen.

6.6 OVERBRIDGE

The Overbridge software enables a tight integration between the Digitakt II and a computer DAW software. When using Overbridge, the user interface for the Digitakt II presents itself as a plug-in window in your DAW. Access, edit and automate parameters for sound shaping on screen. Always find your device preset parameters in the same state as you left them when you return to your DAW project, with the useful total recall functionality.

Read more about Overbridge use and availability on the Elektron website: <https://www.elektron.se/overbridge/>



Overbridge for Digitakt II is still under development and is not currently available.

6.7 CLASS COMPLIANT DEVICE

The Digitakt II is a class compliant device (also known as plug-and-play). It means it does not require any extra drivers to connect to your computer or other USB class compliant hosts.

The Digitakt II can, therefore, stream audio and MIDI directly over USB to and from supported computers/phones/tablets. It opens up several exciting possibilities of what you can do with your device, for example, record audio from your device directly over USB in your DAW. For more information, please see "14.8.1 USB CONFIG" on page 81.

6.8 BACKING UP THE DIGITAKT II

It is always recommended to make regular backups of your data. Backups are also a convenient way to share your projects, Presets, and samples with other users. To make backups and transfer files to and from your Elektron device, you should use Transfer, a free application that you can download from the Elektron site <https://www.elektron.se/support>. The application is available for both Windows and macOS.

6.8.1 BACKING UP PROJECTS, PRESETS AND SAMPLES

You can backup your projects, presets and samples from your Elektron device to a computer. Here is the general procedure for how to back up your device:

1. Connect the Elektron device to the computer via USB.
2. Open the Transfer application on your computer, and then select the USB MIDI port(s) for your device on the CONNECTION page, and then click "CONNECT" next to your device under AVAILABLE DEVICES.
3. In Transfer, click the EXPLORE tab to open the EXPLORE page.
4. On the EXPLORE page top left side of the drop-down menu, make sure "MY COMPUTER" is selected.
5. On the top right side, in the drop-down menu, select the type of file you want to transfer.
6. In the window on the right, navigate to the files or folders you want to transfer
7. Drag and drop the files or folders to your preferred location under "MY COMPUTER."

6.8.2 TRANSFERRING BACKED UP FILES TO YOUR ELEKTRON DEVICE

Use the EXPLORE page in Transfer to transfer previously backed up files to your Elektron device from a computer.

1. Connect the Elektron device to the computer via USB.
2. Open the Transfer application on your computer and then select the USB MIDI port(s) for your device on the Transfer CONNECTION page. Click "CONNECT" next to your device under AVAILABLE DEVICES.
3. In Transfer, click the EXPLORE tab to open the EXPLORE page.
4. On the top right side, in the drop-down menu, select the type of file you want to transfer.
5. On the top left side in the drop-down menu, make sure "MY COMPUTER" is selected.
6. Under "MY COMPUTER," navigate to the files or folders you want to transfer.
7. Drag and drop the files or folders to your preferred location on your device.
8. Depending on what file type you send, you might encounter pop-up windows asking you to decide what files you want to send and how you want to organize them.



It is possible to import Digitakt I projects to Digitakt II. However, due to changes in the device architecture, the patterns in the projects might not be 100% the same in some cases.

7. QUICK START

This quick start will guide you through some of the basic operations to start using the Digitakt II right away. First, connect it as described in section "3.3 SETTING UP AND STARTING THE DIGITAKT II" on page 14.

7.1 PLAYING THE FACTORY PRESETS

You can find a number of preset patterns, presets, and samples in the Digitakt II. Follow the instructions below to get started exploring your new instrument.

1. Press **[PTN]** and then use the **[LEFT]/[RIGHT]** keys to select bank A. Then press **[TRIG 1]** to select pattern A1.
2. Press **[PLAY]** to listen to pattern A01.
3. Press **[PTN]**, and then press **[TRIG 2]** to cue pattern A02. It will start once pattern A01 has reached its end. Select pattern A03 by pressing **[PTN]**, and then press **[TRIG 3]**, and so on.
4. Press **[STOP]** to stop playback.

7.1.1 USING KEYBOARD MODE

You can use the **[TRIG]** keys to play any track chromatically.

1. Select the track to play chromatically by pressing **[TRK]** + one of the **[TRIG 1–16]** keys.
2. Press **[KEYBOARD]** to enter KEYBOARD mode. The **[TRIG]** keys will light up in a pattern that resembles an octave of a piano keyboard. Only lit keys are playable.
3. Play the **[TRIG]** keys. The preset will be pitched differently for each of the playable keys. Press **[KEYBOARD]** + **[UP]/[DOWN]** to transpose the virtual keyboard up or down one octave.

For more information, please see "8.5.1 KEYBOARD MODE" on page 25.



KEYBOARD mode is an effective way to add musical variety to your beats. The timbre, tonality and impact of playing a preset chromatically depend on the character of the source preset.

7.1.2 USING MUTE MODE

You can mute any of the sequencer tracks in this mode. Unlike the KEYBOARD mode, it makes no difference which track is active when this mode is activated. You can access all tracks simultaneously.

1. Make sure a pattern is playing.
2. Press the **[FUNC]** + **[TRK]** key to enter MUTE mode.
3. Press any of the **[TRIG]** keys to mute the corresponding track. Press again to unmute. The light of the **[TRIG]** keys indicates the mute status. Unlit keys are muted tracks. Lit keys are active tracks.

For more information, please see "8.5.3 MUTE MODE" on page 26.

7.1.3 TEMPO AND METRONOME

Press the **[TEMPO]** key to open the TEMPO menu.

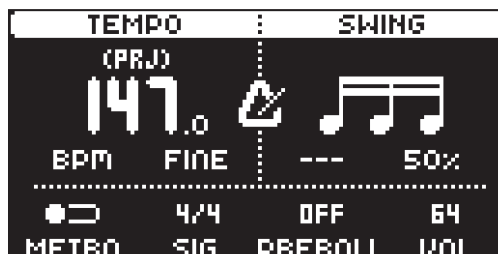

TEMPO

To change the BPM setting, open the TEMPO menu by pressing the **[TEMPO]** key. Use **DATA ENTRY** knob **A** or **LEVEL/DATA** to change tempo. Pressing the knob while turning it changes the tempo four BPM at a time. Use **DATA ENTRY** knob **B** to change the tempo in decimal steps. You can choose between a tempo for the whole project or use a separate tempo every pattern. Press and hold the **[FUNC]**, and then use **DATA ENTRY** knob **E** to switch between these modes. On the main interface screen, you can also press and hold the **[ARROW]** keys **[LEFT]** or **[RIGHT]** to nudge the tempo 10% up or down temporarily. Release the key to revert to the original tempo.

To tap a tempo setting, hold the **[FUNC]** key and tap the **[TEMPO]** key in a steady rhythm. After four consecutive taps the average tempo of the taps will be calculated. By continuing tapping, the average tempo will keep on updating.

When in the TEMPO menu (and with PROJECT tempo mode selected), holding **[FUNC]** while turning **DATA ENTRY** knob **A** will not change the tempo to the selected value until the **[FUNC]** key is released. While doing this, "PREP." flash in the bottom left corner of the screen.



Nudging the tempo is very handy when manually syncing Digitakt II to a turntable or an external sound source. Note that you do not need to be in the TEMPO menu to nudge the tempo.

DATA ENTRY knob **D** to adjust the swing setting of the pattern, to employ a propulsive, rhythmic groove. The swing ratio can be set to 51-80%. The default setting is equal spacing, 50%.

METRONOME

The metronome settings controls the internal metronome of the Digitakt II. Use the **DATA ENTRY** knobs to change the settings.

METRO activates/deactivates the metronome.

SIG. controls the note and beat measure of the metronome time signature.

PREROLL controls for how many bars the metronome will sound before the sequencer starts playing. This setting is only relevant when you are in LIVE RECORDING mode.

VOL controls the volume of the click.

7.1.4 EDITING PARAMETERS

Each track has six **PARAMETER** pages. Press **[PARAMETER]** keys TRIG, SRC, FLTR, AMP, FX, and MOD to access the different **PARAMETER** pages. These parameters affect the sound and signal in various ways.

1. Make sure a pattern is playing.
2. Press **[TRK]** + **[TRIG]** keys 1-16 to select a track.
3. To change, for example, the cutoff of the filter, press the **[FLTR]** key to open the FILTER page. The parameter labeled **FREQ** changes the cutoff of the filter. Turn **DATA ENTRY** knob **E** to change the parameter value, and hear how the sound is affected.

Try out the rest of the **PARAMETER** page parameters to explore a variety of sound shaping possibilities.

7.2 SAMPLING FROM THE EXTERNAL INPUTS

Digitakt II can also sample audio. It can sample audio from external sources, via the external inputs, and it can also sample audio internally from the Digitakt II itself.

1. Connect your audio source to the **IN L/R** inputs of the Digitakt II.
2. Press **[SAMPLING]** to access the SAMPLING menu and then use **DATA ENTRY** knob **A** to set **SOURCE** to IN L R.
3. Keep an eye on the audio input meter and play the audio source and make sure that the volume of the audio source is as strong as possible, but without clipping or distorting. Set **MON** to POST MIX to monitor the incoming audio through the Digitakt II's mixer and effects.
4. Again, with an eye on the audio input meter, use **DATA ENTRY** knob **D** to set **THRESHOLD** just above the indicated background noise of the audio source (when it is not playing).
5. Use **R.LEN** to set the length of the sampling.
6. Switch **ARM** to ON to arm the sampler and then play the sound source. When the input audio exceeds the set **THRESHOLD** level, sampling will start.
7. Press **[YES]** when you want to stop sampling, or with an **R.LEN** setting of 1-128, the sampling stops automatically. The sampling also stops if it reaches the max sampling time (66 seconds). The Digitakt II then automatically normalizes the sample.
8. Use the **DATA ENTRY** knobs **E** and **H** to set the parameters **TRIM START** and **TRIM END** to trim the sample to the desired length. You can use the **DATA ENTRY** knob **F** to zoom in and out to make it easier to see where to trim the sample. Use **[FUNC]** + **F** to zoom vertically. Use knob **G** to position the zoom focus area. **[FUNC]** + **G** moves the trim selection left or right. When zoomed, pressing **[LEFT]** will jump to the START trim point, and **[RIGHT]** will jump to the END trim point. Press **[FUNC]** + **[YES]** to preview the sample. **DATA ENTRY** knobs **D** selects the way the sample will be previewed. One shot, Looping, One shot (without having to hold the shortcut all the way), Looping (without having to hold

7. QUICK START

the shortcut all the way). The preview is played back by the voice of the active track. Make sure to select an audio track as active track.

9. Press **[YES]** to save the sample.

10. Name the sample and press **[YES]** again to confirm the save.

11. Press **[TRACK 1-16]** to select the track to where you want to assign the sample.

For more information, please see "13. SAMPLING" on page 68.

8. DIGITAKT II CONTROLS

8.1 TRIG KEYS

The **[TRIG]** keys have several uses, including for example, triggering an audio/MIDI track from the active pattern. (When sequencer recording is deactivated). They are also used for placing trigs in GRID RECORDING mode. When pressed in combination with the **[PTN]** and **[SONG]** keys, they select patterns and songs. The **[TRIG]** keys light up to indicate the position of placed trigs and to indicate the selected bank and track.

8.2 ROTARY ENCODERS

The **MAIN VOLUME** is an absolute encoder, spanning roughly 320 degrees from its left extreme to its right extreme. The **LEVEL/DATA** and **DATA ENTRY** knobs (with which you set various parameter values), are relative encoders which may be spun any number of turns. Pressing and turning these encoders will change their associated values at a greater speed.

8.3 KEY BEHAVIOR

As a group, the track selection keys (**[TRIG]** keys) have radio button functionality, i.e. when a new track is set to be active, the previous one is simultaneously deactivated. Only one track can be selected at a time. Likewise, the group consisting of the six **[PARAMETER]** keys have radio button functionality.

8.4 MIDI NOTES

Some functions can be triggered by sending MIDI note values from an external MIDI device (a MIDI keyboard or a computer, for example) connected to the Digitakt II via a standard MIDI cable or a USB 2.0 A to B connector cable.

Of the 128 notes in the standard MIDI range, Note numbers 0–7 correspond to notes C0 through to G0, the leftmost octave (which is sometimes called C-2–G-2 in certain applications). These notes will trigger the preset of track 1 through track 8, respectively (provided they are set to their default channels 1-8). These notes values map to each of the eight tracks, regardless of which track is active.

MIDI note numbers 12–84, that corresponds to notes C1–C7 (C5, MIDI note 60, being middle C) will trigger the preset of the active track in any of its 73 chromatic variations (as if played by the **[TRIG]** keys in KEYBOARD mode, see section below), from lowest to highest pitch.

MIDI program change messages 0–127 will select pattern 1–128 (A01–H16) on the Digitakt II. Additionally, MIDI CC and NRPN messages can be sent to control various aspects of the Digitakt II. For more information, please see "APPENDIX B: MIDI" on page 104.

8.5 MODES

There are several modes of operation on the Digitakt II that decides what action the **[TRIG]** keys perform when pressed.

8.5.1 KEYBOARD MODE

Press **[KEYBOARD]** to enter KEYBOARD mode. In this mode, you can play the preset of the active audio track (or send MIDI notes if you have an active MIDI track). With **KB SCALE** set to CHROMATIC and **KB FOLD** set to OFF the **[TRIG]** keys will light up in a pattern that resembles an octave of a piano keyboard layout. Only lit keys are playable. Press **[TRK]** + **[TRIG 1-16]** keys to select the track you want to play.

Press the trig keys to change the note pitch of the preset. The range from **[TRIG 9]** key to **[TRIG 16]** key is one octave. The whole note range you can trig for spans a little more than 10 octaves (C0–G10) You can transpose the keyboard 4 octaves up and 5 octaves down from the middle octave. Press **[KEYBOARD]** + **[UP]/[DOWN]** to transpose the virtual keyboard up or down in octave steps. With **U/D KEY MODE** set to KB OCT, just press **[UP]/[DOWN]** to transpose the virtual keyboard when you are in KEYBOARD mode. For more information, please see "14.7.4 U/D KEY MODE" on page 81.

Notes triggered can be recorded on the sequencer in LIVE RECORDING mode. Find out how this is done in section "10.2.3 LIVE RECORDING MODE" on page 42.

The active state of KEYBOARD mode (the portion of the keyboard currently visible on the **[TRIG]** keys) is not stored per pattern but stays in the state as it was last set.

Press **[KEYBOARD]** again to exit KEYBOARD mode.

8.5.2 KEYBOARD SETUP MENU

Press **[FUNC]** + **[KEYBOARD]** to open the KEYBOARD SETUP menu. Here you get a graphical view of which notes the **[TRIG]** keys play. Press **[UP]/[DOWN]** to transpose the keyboard up or down an octave.

In this menu, you can also set different musical scales, and select the root note of the scale. Use the **DATA ENTRY** knobs to change the settings. Press **[NO]** to exit the menu. Press **[KEYBOARD]** again to exit KEYBOARD mode. The settings are stored in the active pattern.

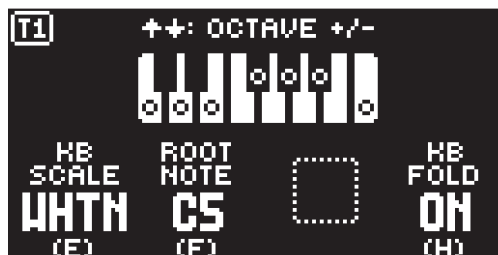

KB SCALE sets the track's scale. This setting governs which notes are playable on the Digitakt II's **[TRIG]** keys to allow only notes in the set scale. For a list of all selectable keyboard scales, please see "APPENDIX D: KEYBOARD SCALES" on page 110.

ROOT NOTE sets the root note for the chosen scale.

KB FOLD When set to ON, **KB FOLD** changes the way the notes are laid out on the **[TRIG]** keys and how they are played from external MIDI devices. Now all the **[TRIG]** keys trigger a note. The **[TRIG 9]** key plays the lowest note of the selected octave, root note and scale. The notes are then played upwards through the scale to **[TRIG 16]** and then further upwards on **[TRIG 1–8]**. When a scale contains less than eight notes in an octave, the "remaining" **[TRIG]** keys on the lower row will play the same notes as the first **[TRIG]** keys on the upper row. Blue **[TRIG]** keys signal that they contain notes that are one or more octaves distanced from each other.

In the following example of the whole tone scale **[TRIG 15–16]** keys play the same notes as the **[TRIG 1–2]** keys. **[TRIG 1]** and **[TRIG 15]** both play a note that is one octave above **[TRIG 9]**. **[TRIG 7]** plays a note that is two octaves above **[TRIG 9]**.

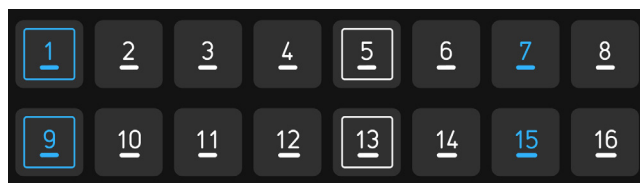

You can also use an external keyboard to play the active tracks preset chromatically. Connect the keyboard to the Digitakt II and configure the external keyboard and the Digitakt II MIDI Auto Channel (**SETTINGS > MIDI CONFIG > CHANNELS**) to the same MIDI channel. Then play the keys on the external keyboard to play the active tracks preset chromatically. You can play the active track's preset chromatically even if the Digitakt II is not in **KEYBOARD** mode.



All the settings in the **KEYBOARD SETUP** menu are ignored for a track that uses the Grid machine and when **SLICE** is set to **NOTE**. Instead slices play from **C1** and upwards, wrapping around after the last slice. The first slice is highlighted with a blue **[TRIG]** key in **KEYBOARD** mode.

8.5.3 MUTE MODE

You can use **MUTE** mode to mute any of the 16 sequencer tracks. Unlike **KEYBOARD** mode, it makes no difference which track is active when you enter **MUTE** mode. All tracks are accessed simultaneously. Press any of the **[TRIG]** keys to mute the corresponding track. Press again to unmute. The color of the **[TRIG]** keys indicates its tracks mute status. Lit keys signify unmuted tracks. Unlit keys signify muted tracks.

There are two different versions of **MUTE** mode on the Digitakt II:

- **GLOBAL MUTE MODE** In **GLOBAL MUTE** mode, the muted tracks are muted in all patterns. In this mode, the **[TRACK]** keys are lit green. If a track with trigs placed on it is muted in **GLOBAL MUTE** mode, its **[TRACK]** key blinks green when the pattern plays. Press **[FUNC] + [TRK]** to enter **GLOBAL MUTE** mode. Press **[FUNC] + [TRK]** to exit **GLOBAL MUTE** mode.
- **PATTERN MUTE MODE** In **PATTERN MUTE** mode, the muted tracks are muted only in the active pattern. In this mode, the **[TRACK]** keys are lit magenta. If a track with trigs placed on it is muted in

PATTERN MUTE mode, its [TRACK] key blinks magenta when the pattern plays.

Press [FUNC] + double-press [TRK] to enter PATTERN MUTE mode.

Press [FUNC] + [TRK] to exit PATTERN MUTE mode.

The GLOBAL MUTE mode settings are saved together with the project. The PATTERN MUTE mode settings are saved together with the pattern.

If a track with trigs placed on it is muted in PATTERN MUTE and GLOBAL MUTE mode, its [TRACK] key blinks magenta in both modes when the pattern plays.

You can also prepare tracks for muting/unmuting before the mute action takes effect. While in any MUTE mode, press and hold [FUNC] and then press the [TRIG] keys corresponding with the tracks you want to mute/unmute. The selected track will then be muted/unmuted when you release [FUNC]. At the top of the screen you can see an overview of the mute status for all the tracks. Square = unmuted track, horizontal line = muted track, a plus sign = a track prepared to be unmuted, an X = track prepared to be muted.



- You can also use QUICK MUTE to mute and unmute sequencer tracks. Press and hold [FUNC] and then press the [TRACK] keys to mute or unmute tracks.
- Digitakt II remembers the last used version of MUTE mode and will access this one first when you press [FUNC] + [TRK]. This also applies to QUICK MUTE. However, after reboot, it always defaults back to GLOBAL MUTE mode.

8.5.4 TRIG MODE

The various TRIG modes affect the functionality of the [TRIG 1-16] keys. Press [FUNC] + [UP] or [DOWN] to select which TRIG mode that should be active. The selected TRIG mode is active for all the tracks. All actions performed using the trig modes can be recorded in LIVE RECORDING mode.



TRACKS

This is the default TRIG mode. In this mode, the [TRIG 1-16] keys triggers the corresponding audio/MIDI tracks.

VELOCITY

In this TRIG mode, the [TRIG 1-16] keys triggers the active track with different amounts of velocity.

Trig 1 = Velocity 8

Trig 2 = Velocity 16

Trig 3 = Velocity 24

Trig 4 = Velocity 32

Trig 5 = Velocity 40

Trig 6 = Velocity 48

Trig 7 = Velocity 56

Trig 8 = Velocity 64

Trig 9 = Velocity 72

Trig 10 = Velocity 80

Trig 11 = Velocity 88

Trig 12 = Velocity 96

Trig 13 = Velocity 104

Trig 14 = Velocity 112

Trig 15 = Velocity 120

Trig 16 = Velocity 127

RETRIGS

In this TRIG mode, the [TRIG 1-16] keys triggers the active track with different amounts retrig rates.

Trig 1 = Retrig rate 1/1

Trig 2 = Retrig rate 1/2

Trig 3 = Retrig rate 1/3

Trig 4 = Retrig rate 1/4

Trig 5 = Retrig rate 1/5

Trig 6 = Retrig rate 1/6

Trig 7 = Retrig rate 1/8

Trig 8 = Retrig rate 1/12

Trig 9 = Retrig rate 1/16

Trig 10 = Retrig rate 1/20

Trig 11 = Retrig rate 1/24

Trig 12 = Retrig rate 1/32

Trig 13 = Retrig rate 1/40

Trig 14 = Retrig rate 1/48

Trig 15 = Retrig rate 1/64

Trig 16 = Retrig rate 1/80

PRESET POOL

In this TRIG mode, the [TRIG 1-16] keys triggers sixteen preset slots in the preset pool. The first page triggers the presets in slots 1-16. Press [PAGE] + [RIGHT] to go to page 2 to triggers the presets in slots 17-32 and so on. Press [PAGE] + [LEFT/RIGHT] to select which slots you wish to trigger. For more information, please see "9.1 THE +DRIVE LIBRARY AND THE POOL" on page 29.



Incoming MIDI note data are mapped to the tracks in different ways depending on the chosen TRIG mode.



The RETRIGS and PRESET POOL trig modes only works on audio tracks.

9. PATTERNS, KITS, PRESETS, AND SAMPLES

The patterns are the primary data container for the Digitakt II. Sixteen patterns are available for each of the eight banks, which means that 128 patterns are available for each project. A pattern contains up to 16 presets (one for each track), sequencer data like trigs and parameter locks. It also contains the default settings on the TRIG page and BPM, length, swing and time signature settings.

A kit is a collection of 16 presets, one for every track together with a number of kit related settings. A preset is either a sample, plus all the settings in the PARAMETER pages (SRC, FLTR, AMP, FX, and MOD) or a MIDI preset containing settings in the PARAMETER pages (SRC, FLTR, AMP, and MOD). Any preset can be assigned to any of the 16 tracks.

A preset or kit that has been imported from the +Drive to a pattern becomes part of the active pattern. Any changes made to a preset/kit will therefore not affect the stored preset/kit. It will only affect the preset/kit in the active pattern. You can export (and in that way save) a preset/kit from the active pattern to the +Drive. For more information, please see "9.3 PRESET/KIT MENU" on page 30.

A sample that is used in a preset or a pattern can be renamed or moved and still work as intended. This is due to a hash function that adds a file specific value to every file, and this value is independent of the file name or the file's location in the data structure. However, if you delete a sample, it will not be included in any presets or patterns anymore.



- When a preset or a kit is imported to a pattern, it becomes a copy of the preset/kit on the +Drive and is not linked to the original preset/kit stored on the +Drive. Instead, it fully becomes a part of the pattern.
- If you delete a sample from the +Drive, it will not be included in any presets or patterns anymore.

A pattern contains:

- A kit.
- Sequencer data such as trigs and parameter locks for the 16 tracks.
- The settings on the TRIG page, BPM, length, swing and time signature settings.

A kit contains:

- 16 audio or MIDI track presets.
- LEVEL settings for the audio tracks and the pattern.
- Compressor and Master distortion settings
- Compressor routing and Control all settings
- Send FX settings

A preset contains:

- A sample (linked from the +Drive), plus the SRC, FLTR, AMP, FX and MOD PARAMETER pages settings for the audio track. Or, in the case of MIDI presets, the SRC, FLTR, AMP, and MOD PARAMETER pages settings for the MIDI track.

A sample is:

- A 16 bit, 48 kHz, mono or stereo audio file.

9.1 THE +DRIVE LIBRARY AND THE POOL

The total size of the +Drive is 20 GB. The +Drive library can hold up to 2048 presets (256 presets in each bank A-H) that are available to all projects. The kits are also stored here. The +Drive library also contains the samples. You can load up to 400 MB (about 72 minutes in mono, 36 minutes in stereo) of samples to a project. A sample must be imported to a projects pool, for it to be sample locked.

Presets can be loaded to a pattern from either the +Drive library or the pool (Project RAM) of the active project. The difference between the two is that the +Drive library has the capacity of 2048 presets, available to all projects, while the pool is a part of a project and limited to 128 presets. The primary benefit of presets loaded to the pool is the possibility for them to be preset locked. This feature is not available for the presets in the +Drive library. For more information, please see "10.8.2 PRESET LOCKS" on page 47.

9.1.1 ADDING PRESETS TO THE POOL

You must first add presets to the pool to be able to perform preset locks.

1. Press [PRESET/KIT] to open the PRESET/KIT menu.
2. Select (PRESET) **MANAGE**, and then press [YES] to open the PRESET MANAGER.

3. Select the presets you want to add to the pool by highlighting them and pressing [YES].
4. Press [LEFT] to open the PRESET SORTING menu.
5. Select ADD TO PRESET POOL and then press [YES].



MIDI presets can not be added to the preset pool

9.2 PRESET BROWSER



Press [FUNC] and then turn *LEVEL/DATA* to open the PRESET BROWSER. The preset browser can also be accessed by pressing [PRESET/KIT], and then selecting (PRESET) LOAD. The PRESET BROWSER is used to preview and load presets. This menu will show a list of all presets in the +Drive library. Scroll the list by turning the *LEVEL/DATA* knob or by pressing [UP]/[DOWN]. Press [LEFT] to open the PRESET SORTING menu and then use the SEL BANK option to select preset bank A–H. Press [FUNC] + [YES] to preview the preset before you load it to the track. Press [YES] to load the preset to the track.

Press [LEFT] to access the SORTING menu. Press [YES] to execute the commands. Press [NO] or the [RIGHT] arrow key to exit the menu.

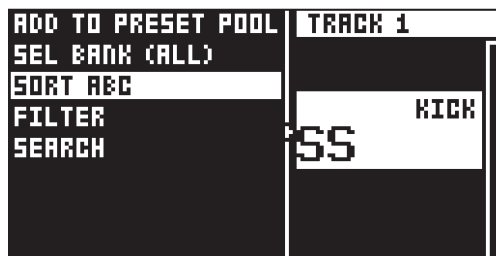

ADD TO PRESET POOL adds the selected preset to the pool of the active project.

SELECT BANK opens the Preset bank selector. The currently selected bank is shown in parenthesis. Use the [TRIG 8–16] keys, the [ARROW] keys, or *LEVEL/DATA* to select bank.

SORT ABC / SORT 123 toggles between if the presets are sorted in alphabetical order or by slot number.

FILTER opens a list where presets can be arranged according to tags. Select and deselect tags by pressing [YES]. You can select multiple tags. Exit the tag list by pressing [NO].

SEARCH will perform a text search and list all presets with names matching or including the text input. For more information, please see "6.5 THE NAMING SCREEN" on page 19 on how to enter text.

9.3 PRESET/KIT MENU

Press [PRESET/KIT] to open the PRESET/KIT menu. Here you manage presets (both on the +Drive and in the pool) and kits. Use the [ARROW] keys and *LEVEL/DATA* to navigate the menu. Press [YES] to select menu item. Press [NO] to exit the menu.

9.3.1 LOAD (PRESET)

Use the [ARROW] keys or *LEVEL/DATA* to select a preset. Press [YES] to load the preset to the active track. Press [TRK] + [TRIG 1–16] to change active track. Press the tacks [TRIG] key to preview the highlighted preset before you load it. Press KEYBOARD, and then use the [TRIG] keys to preview the selected preset in the selected scale.

Press [LEFT] to access the SORTING menu. Press [YES] to execute the commands. Press [NO] or the [RIGHT] arrow key to exit the menu.



ADD TO PRESET POOL adds the selected preset to the pool of the active project.

SELECT BANK opens the Preset bank selector. The currently selected bank is shown in parenthesis. Use the [TRIG 8–16] keys, the [ARROW] keys, or *LEVEL/DATA* to select bank.

SORT ABC / SORT 123 toggles between if the presets are sorted in alphabetical order or by slot number.

FILTER opens a list where presets can be arranged according to tags. Select and deselect tags by pressing [YES]. You can select multiple tags. Exit the tag list by pressing [NO].

SEARCH will perform a text search and list all presets with names matching or including the text input. For more information, please see "6.5 THE NAMING SCREEN" on page 19 on how to enter text.

9.3.2 SAVE (PRESET)

Use this option to save the active tracks preset.

1. Use the [UP]/[DOWN] keys or *LEVEL/DATA* to select a slot to where you want to save the preset.
2. Press [YES] to save the preset to the selected slot. If the slot already contains a preset you are asked to confirm the save operation.
3. On the NAMING screen, name your preset and then press [YES]. For more information, please see "6.5 THE NAMING SCREEN" on page 19.
4. On the TAG screen you can add tags to the preset. The first two will show on the preset list. Press [YES] to apply or remove tags. Highlight <SAVE> and press [YES] to save.

ADD TO PRESET POOL adds the selected preset to the pool of the active project.

SELECT BANK opens the Preset bank selector. The currently selected bank is shown in parenthesis. Use the [TRIG 8–16] keys, the [ARROW] keys, or *LEVEL/DATA* to select bank.

SORT ABC / SORT 123 toggles between if the presets are sorted in alphabetical order or by slot number.

FILTER opens a list where presets can be arranged according to tags. Select and deselect tags by pressing [YES]. You can select multiple tags. Exit the tag list by pressing [NO].

SEARCH will perform a text search and list all presets with names matching or including the text input. For more information, please see "6.5 THE NAMING SCREEN" on page 19 on how to enter text.

SHOW ALL SLOTS will, when ticked, show all the preset slots both populated and empty. When not ticked, it only shows empty slots.

9.3.3 MANAGE (PRESET)

Opens the Preset manager. Here presets can be saved, loaded, renamed, tagged et cetera. Opening this menu will show a list of all presets found in the +Drive library.

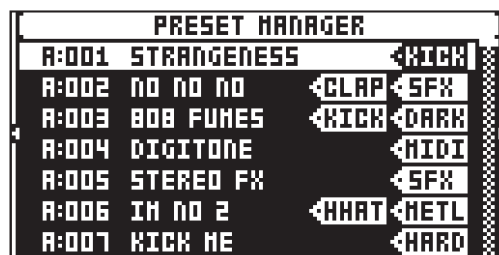

Press [LEFT] to access the SORTING menu. Press [YES] to execute the commands. Press [NO] or the [RIGHT] key to exit the menu.



ADD TO PRESET POOL adds the selected preset to the pool of the active project.

SELECT BANK opens the Preset bank selector. The currently selected bank is shown in parenthesis. Presets in the +Drive library are organized into eight banks, ranging from A to H. Each bank can contain 256 presets. Use the [TRIG 9-16] keys to view only presets located in a specific bank. Use the [TRIG 8-16] keys, the [LEFT /RIGHT] keys, or **LEVEL/DATA** to select bank.

SORT ABC / SORT 123 toggles between if the presets are sorted in alphabetical order or by slot number.

FILTER opens a list where presets can be arranged according to tags. Select and deselect tags by pressing [YES]. You can select multiple tags. Exit the tag list by pressing [NO].

SEARCH will perform a text search and list all presets with names matching or including the text input. For more information, please see "6.5 THE NAMING SCREEN" on page 19 on how to enter text.

SHOW ALL SLOTS will, when ticked, show all the preset slots both populated and empty. When not ticked, it only shows empty slots.

Press [RIGHT] to access the PRESET OPERATIONS menu. The available operations will affect the highlighted preset. Use **LEVEL/DATA** or the [UP]/[DOWN] arrow keys to navigate the menu. Press [YES] to apply the commands to the selected preset. Press [NO] or the [LEFT] arrow key to exit the menu.



LOAD TO TRACK loads the selected preset to the active track and makes it a part of the active pattern.

COPY TO BANK copies the selected presets to the first free slots of a specific bank inside the +Drive.

SAVE TO HERE saves the active track preset to the selected slot.

RENAME Opens a screen where you can rename the selected preset.

EDIT TAGS opens a menu where presets can be tagged. presets can have any number of tags, but only the first two will show on the preset list. Press [YES] to apply or remove tags. Highlight <SAVE> and press [YES] to save.

DELETE deletes the preset or selected presets.

SELECT ALL selects all presets in the list.

DESELECT ALL deselects all selected presets in the list.

TOGGLE enables or disables write protection for the selected presets. When a preset is write protected it cannot be overwritten, renamed, tagged or deleted. A write protected preset has a padlock symbol next to its name. The command is only available when you browse the +Drive library.

SEND SYSEX sends the selected presets as SysEx data.



- It is also possible to save/load/manage MIDI track presets in the same way as you do with audio track presets. They will automatically be tagged with the MIDI tag when they are saved. It is not possible to load a MIDI preset to the preset pool.
- You can preview the currently selected preset by pressing the [TRIG 1–16] key of the active track. All presets available for the active track can be previewed. Please note that if the previewed preset is sent to the effects, the current effects settings will affect it.
- Several presets can be simultaneously affected by the commands available in the SOUND OPERATIONS menu. Select/deselect individual presets by highlighting them and pressing [YES].
- Press [FUNC] + [UP]/[DOWN] for faster scrolling in the preset list.

9.3.4 POOL

Provides a quick access to the pool in the Preset manager. Here you can manage the preset pool. You can, among other things add presets, select multiple presets, delete presets, and rename presets.

Press [RIGHT] to access the PRESET OPERATIONS menu. The available operations will affect the highlighted preset. Use *LEVEL/DATA* or the [UP]/[DOWN] arrow keys to navigate the menu. Press [YES] to apply the commands to the selected preset. Press [NO] or the [LEFT] arrow key to exit the menu.

PRESET	LOAD TO TRACK
:::001 STRANGE	SAVE TO HERE
:::002 NO NO N	RENAME
:::003 BOB FUM	DELETE
:::004 STEREO	SELECT ALL
:::005 IN NO 2	SELECT UNUSED
:::006 KICK ME	DESELECT ALL
:::007 / / / / /	

LOAD TO TRACK loads the selected preset to the active track and makes it a part of the active pattern.

SAVE TO HERE saves the active track preset to the selected slot.

RENAME Opens a screen where you can rename the selected preset.

DELETE deletes the preset or selected presets.

SELECT ALL selects all presets in the list.

SELECT UNUSED selects all presets that are not used in any pattern in the project.

DESELECT ALL deselects all selected presets in the list.

9.3.5 LOAD (KIT)

Use the [ARROW] keys or *LEVEL/DATA* to select a kit. Press [YES] to load the kit to the active pattern. Press the [TRIG] keys to preview the highlighted kit before you load it.

Press [LEFT] to access the SORTING menu. Use *LEVEL/DATA* or the [UP]/[DOWN] arrow keys to navigate the menu. Press [YES] to execute the commands. Press [NO] or the [RIGHT] arrow key to exit the menu.

ADD TO PRESET POOL	TRIG 001
SORT ABC	
SEL BANK (ALL)	
SEARCH	

ADD TO POOL adds the kits 16 presets to the to the pool of the active project.

SORT ABC / SORT 123 toggles between if the kits are sorted in alphabetical order or by slot number.

SELECT BANK opens the KIT bank selector. The currently selected bank is shown in parenthesis. Use the [TRIG 8–16] keys, the [ARROW] keys, or *LEVEL/DATA* to select bank.

SEARCH will perform a text search and list all kits with names matching or including the text input. For more information, please see "6.5 THE NAMING SCREEN" on page 19 on how to enter text.

9.3.6 SAVE (KIT)

Use this option to save the active patterns kit.

1. Use the [UP]/[DOWN] keys or **LEVEL/DATA** to select a slot to where you want to save the kit.
2. Press [YES] to save the kit to the selected slot. If the slot already contains a kit you are asked to confirm the save operation.
3. On the NAMING screen, name your kit and then press [YES] to save. For more information, please see "6.5 THE NAMING SCREEN" on page 19.

Press [LEFT] to access the SORTING menu. Press [YES] to execute the commands. Press [NO] or the [RIGHT] arrow key to exit the menu.

ADD TO POOL adds the kits 16 presets to the to the pool of the active project.

SORT ABC / SORT 123 toggles between if the kits are sorted in alphabetical order or by slot number.

SELECT BANK opens the KIT bank selector. The currently selected bank is shown in parenthesis. Use the [TRIG 8-16] keys, the [ARROW] keys, or **LEVEL/DATA** to select bank.

SEARCH will perform a text search and list all kits with names matching or including the text input. For more information, please see "6.5 THE NAMING SCREEN" on page 19 on how to enter text.

SHOW ALL SLOTS will, when ticked, show all the kit slots both populated and empty. When not ticked, it only shows empty slots.

9.3.7 MANAGE (KIT)

Kits can be saved, loaded, renamed, tagged et cetera. Opening this menu will show a list of all presets found in the +Drive library.



Press [LEFT] to access the SORTING menu. Press [YES] to execute the commands. Press [NO] or the [RIGHT] key to exit the menu.



ADD TO POOL adds the kits 16 presets to the to the pool of the active project.

SORT ABC / SORT 123 toggles between if the kits are sorted in alphabetical order or by slot number.

SELECT BANK opens the KIT bank selector. The currently selected bank is shown in parenthesis. Use the [TRIG 8-16] keys, the [ARROW] keys, or **LEVEL/DATA** to select bank.

SEARCH will perform a text search and list all kits with names matching or including the text input. For more information, please see "6.5 THE NAMING SCREEN" on page 19 on how to enter text.

Press [RIGHT] to access the KIT OPERATIONS menu. The available operations will affect the highlighted preset. Press [YES] to apply the commands to the selected kit. Press [NO] or [LEFT] arrow key to exit the menu.

HIT	LOAD TO PATTERN
A:001 NEW DON	COPY TO BANK...
A:002 NEW DON	SAVE TO HERE
A:003 TUFFIN	RENAME
A:004 ACOUST	DELETE
A:005 ELECTR	SELECT ALL
A:006 PUFF D	DESELECT ALL
A:007 TECHN	TOGGLE

LOAD TO PATTERN loads the selected kit to the active pattern.

COPY TO BANK Copies the selected kits to BANK (A-H) The kit is copied to the first free slot of a specific bank inside the +Drive.

SAVE TO HERE saves the active kit to the selected slot.

RENAME Opens a screen where you can rename the selected kit.

DELETE deletes the kit or selected kits.

SELECT ALL selects all kits in the list.

SELECT UNUSED selects all kits that are not used in any pattern in the project from the pool. The presets are not removed from the +Drive library. Then select **DELETE** to remove the selected kits from the project's pool.

DESELECT ALL deselects all kits in the list.

TOGGLE enables or disables write protection for the selected kits. When a kit is write protected it cannot be overwritten, renamed, tagged or deleted. A write protected kit has a padlock symbol next to its name. The command is only available when you browse the +Drive library.

SEND SYSEX sends the selected kit's presets as SysEx data.

9.4 PLAYING A PRESET

Press the **[TRIG 1-16]** keys to play the presets of the tracks in the active pattern. The **[TRIG]** keys will briefly light up when pressed.

PLAYING A PRESET WITH AN EXTERNAL MIDI UNIT

The presets can also be played using an external MIDI device connected to Digitakt II. The MIDI channels for of each of the tracks can be assigned in the MIDI CHANNELS menu, covered in the section "14.4.3 CHANNELS" on page 78. You can also use an external MIDI unit to play a preset chromatically when you are in **KEYBOARD** mode. For more information, please see "8.5.1 KEYBOARD MODE" on page 25.

9.5 EDITING A PRESET

Select a track for editing by pressing **[TRK]** + one of the **[TRIG 1-16]** keys. When editing the settings of the track, any changes made will be stored as part of the active pattern.

Adjust the overall volume level of the active audio track with the **LEVEL/DATA** knob.

Edit a preset by adjusting the parameters found on the **PARAMETER** pages. Access these pages by pressing a **[PARAMETER]** page key. Use the **DATA ENTRY** knobs **A-H** to change the parameters. For more information, please see "11. TRACK PARAMETERS" on page 53.

The complete preset, with all its parameter settings and sample, may be copied to another track. Press **[TRK]** + **[TRIG 1-16]** + **[RECORD]**, and then press **[TRK]** + **[TRIG 1-16]** + **[STOP]** to paste the preset to the selected track.

9.6 SAVING A PRESET

After you edited the parameters of a preset, you can save it to the +Drive.

1. Press **[PRESET/KIT]** to open the **PRESET/KIT** menu.
2. Select **PRESET > SAVE**, and then press **[YES]**.
3. Turn the **LEVEL/DATA** knob or use the **[UP]/[DOWN]** keys to select an empty slot to where you want to save your preset, and then press **[YES]**.
4. On the **NAMING** screen, name your sound and then press **[YES]**. For more information, please see "6.5 THE NAMING SCREEN" on page 19.

5. On the TAGS screen, use the [ARROW] keys and [YES] key to select the appropriate tags for your sound, and then select <SAVE> and press [YES].

9.7 ASSIGNING A SAMPLE

Any of the 1016 samples loaded to a project may be assigned to a preset on any of the audio tracks. The user samples can be replaced, relocated and otherwise managed in the SAMPLES menu. For more information, please see "13.6 SAMPLES MENU" on page 70.

1. Press [TRK] + [TRIG 1-16] to select a track to assign the sample to.
2. Press [SRC] to open the SOURCE parameter page.

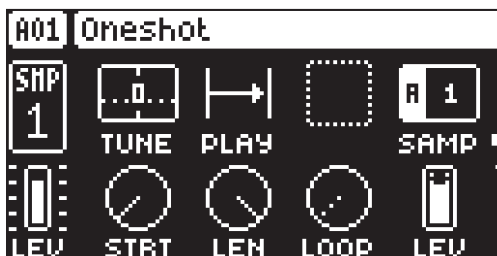

3. Turn *DATA ENTRY* knob *D* to bring up a list of the samples in the pool. For more information, please see "13.6.1 LOADING A SAMPLE" on page 71.

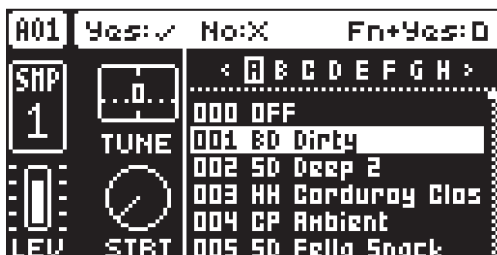

4. Turn the knob counter-clockwise to scroll up the list, clockwise to scroll down the list. Press the [TRIG] key of the active track while browsing to listen to the sample currently outlined.
5. Press [YES] to select a sample. Press [NO] to exit the list without selecting a sample. Press [FUNC] + [YES] to go to the selected samples slot in the +Drive.

9.7.1 ASSIGNING A SAMPLE USING THE QUICK ASSIGN METHOD

You can also use the Quick assign method to load a sample to a track and the project's pool.

1. Press [SRC] to open the SOURCE page, and then turn the knob for the SAMP parameter.
2. While the Sample list is open, press [FUNC] + [YES] to open the SAMPLES menu. For more information, please see "13.6 SAMPLES MENU" on page 70.
3. Navigate to the sample you want to load. Any sample can be previewed (played back by the voice of the active track), just highlight it and then press [FUNC] + [YES]. Approximately, ten seconds of the sample can be previewed.
4. Highlight the sample, and then press [YES] to load it directly to the track and the project's pool.

9.8 THE SETUP MENU

Press [FUNC] + [FLTR] to open the SETUP menu. Here you can set a number of track and kit related parameters. Use the [UP] and [DOWN] arrow keys to move between the options. Press [YES] to confirm your selection. Press [NO] to exit the menu.

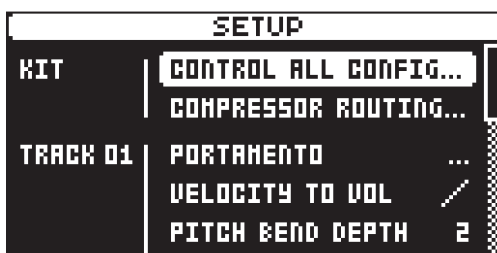

9.8.1 KIT

Here you can select which tracks that should be affected by control all and set up the track routing to the compressor.

CONTROL ALL CONFIG

Use the [TRIG] keys to select which tracks that you want to send to be affected by the control all functionality. MIDI tracks can not be selected. For more information, please see "6.2.2 CONTROL ALL" on page 19.



COMPRESSOR ROUTING

Use the [TRIG] keys to select which tracks, inputs and effects that you want to send to be affected by the compressor. MIDI tracks can not be selected. Use the [UP]/[DOWN] to navigate between the two pages.

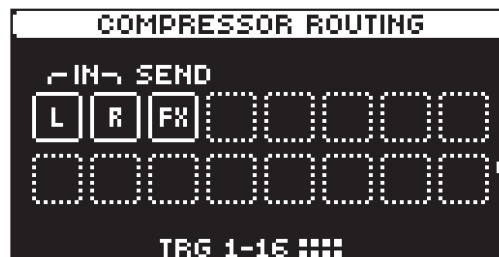

9.8.2 TRACK

Here you can set a number of track related parameters. Use the [UP] and [DOWN] arrow keys to move between the options. Press [YES] to confirm your selection. Press [NO] to exit the menu.

PORTAMENTO

Here you find settings related to the portamento. For more information, please see "10.2 TRIG PARAMETERS PAGE" on page 48.

SLOPE

CONSTANT RATE. The pitch glides linearly at a constant rate. Longer glides take longer time to complete.

CONSTANT TIME The pitch glides linearly, but the glide is completed in a specific time, regardless of the interval between the start and end notes. Glides over wider note intervals, therefore, have a higher rate.

AMOUNT

This setting enables partial glides where just the final part of the interval is included in the glide. For example, a setting of 100 gives a full glide from start to finish. Lower values start the glide closer to the goal pitch.

STYLE

GLIDE Ordinary continuous portamento.

GLISSANDO Quantizes the portamento to semitones.

LEGATO ONLY

ON When playing notes, the pitch glides from the pitch of the last note played and held (the key pressed down and not yet released) to the pitch of the next new note played on the track.

OFF When you play notes, the pitch glides from the pitch of the last note played to the next new note played on the track.

GATING

OFF The glide continues after the key is released.

ON The glide stops when the key is released.

VELOCITY TO VOL

Selects how MIDI velocity affects volume when playing the Sound from a MIDI keyboard.

OFF means velocity does not affect the volume of the sound.

LOG applies a logarithmic velocity curve. The volume difference are greater between softer keyboard presses than between harder.

LIN applies a linear velocity curve. The volume difference between keyboard presses corresponds linearly to the force applied.

EXP applies an exponential velocity curve. The volume difference are greater betwe

PITCH BEND DEPTH

Sets how much the pitch bend data from external MIDI devices affects the Digitakt II.

OCTAVE

Sets the base octave of the preset. It also makes preset locking more practical since you can control the octave setting on the sound and minimize the need to transpose the sequencer notes to make two or more sounds work together.

LEGATO

In LEGATO mode, the envelopes are not triggered by a subsequent note on/key press if the first note is still held.

NOTE PRIORITY

Here you can set the note priority, i.e., what note is played if more than one note is played at the same time. This setting is only available if LEGATO is set to ON.

LAST gives priority to the last note played.

LOW gives priority to the lowest note played.

HIGH gives priority to the highest note played.

PITCH BEND

Opens a menu where you can assign up to four PARAMETER page parameters to the pitch bend. The pitch bend from incoming MIDI sent to the Digitakt II from external devices affects the assigned parameters. Press [YES] to open the menu.

You can select parameters from the SYN, FLTR, AMP, FX, and MOD PARAMETER pages. Turn the **DATA ENTRY** knobs **A–D** to select the track parameters that you wish to assign. Press [YES] to confirm the selection. Then use **DATA ENTRY** knobs **E–H** to set the modulation depth of the four track parameters. The depth is an offset of the original track parameter value.

Turn **LEVEL/DATA** to test your settings.

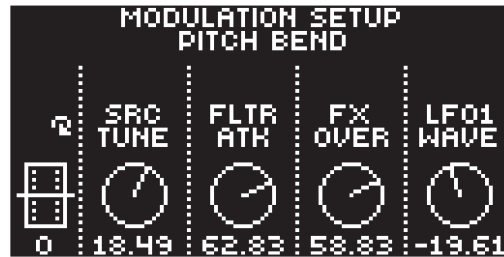

VELOCITY MOD

Opens a menu where you can assign up to four PARAMETER page parameters to the velocity parameter. Both the **VEL** parameter on the TRIG menu and the velocity of incoming MIDI notes sent to the Digitakt II from external devices affects the assigned parameters. Press **[YES]** to open the menu. Selecting parameters and setting modulation depth works in the same way as for **PITCH BEND**.

Turn **LEVEL/DATA** to test your settings.

MOD WHEEL

Opens a menu where you can assign up to four PARAMETER page parameters to the MIDI mod wheel command (CC #1). Press **[YES]** to open the menu. Selecting parameters and setting modulation depth works in the same way as for **PITCH BEND**.

Turn **LEVEL/DATA** to test your settings.

BREATH CONTROLLER

Opens a menu where you can assign up to four PARAMETER page parameters to the MIDI breath controller command (CC #2). Press **[YES]** to open the menu. Selecting parameters and setting modulation depth works in the same way as for **PITCH BEND**.

Turn **LEVEL/DATA** to test your settings.

AFTERTOUCHE

Opens a menu where you can assign up to four PARAMETER page parameters to the MIDI aftertouch command. Press **[YES]** to open the menu. Selecting parameters and setting modulation depth works in the same way as for **PITCH BEND**.

Turn **LEVEL/DATA** to test your settings.

10. THE SEQUENCER

The sequencer of the Digitakt II stores information in patterns. A pattern controls the playback of the tracks and various pattern-specific aspects of the tracks. Each of the eight banks, A to H, contains 16 patterns, which means 128 patterns are available for each project. For more information, please see "14.3 PATTERN MENU" on page 75.

A pattern contains:

- General trig settings on the TRIG page (default note pitch, velocity et cetera).
- The parameter settings on the SCR, FLTR, AMP, FX and MOD pages.
- The settings on the DELAY, REVERB, CHORUS and MIXER pages.
- Quantization settings.
- Note trigs and Lock trigs for all tracks.
- Parameter/Sample/presets locks.
- Length and time signature for the tracks.

10.1 PATTERN OPERATIONS

Digitakt II can seamlessly switch between patterns. This, together with the ability to patterns, is a handy feature when improvising live. For more information, please see "10.1.3 CHAINS" on page 40.

10.1.1 SELECTING BANK AND PATTERN

Press [PTN] and then use the [LEFT]/[RIGHT] keys to select a bank (if you want to select a pattern from another bank than the current). Then press [TRIG 1-16] to select a pattern.

There is a secondary way to change bank and pattern, more similar to earlier Elektron devices. Press [FUNC] + [PTN], and then press [TRIG 9-16] to select a bank. Then press [TRIG 1-16] to select a pattern within that bank.

If you just want to select a pattern within the current bank, press [PTN] + [TRIG 1-16].

Press [PTN] or [NO] to exit bank/pattern selection.

White [TRIG] keys indicate pattern positions that contain data. A red [TRIG] key indicates the current active pattern. Empty patterns are unlit.

When a pattern is playing, and a new pattern is selected, the new pattern position will be shown flashing in the upper left corner of the screen. Once the last step of the pattern has played, the new pattern will start, and the pattern position will cease to flash.



- Patterns can be changed while the sequencer is running.
- Patterns can be changed and queued by sending program change messages.
- It is possible to copy a pattern, and then paste it to one or several locations without leaving the active pattern. You can also clear one or several non-active patterns.
 - To copy, first press [PATTERN]. Then press [TRIG] + [RECORD] to select the pattern you wish to copy and copy it. Then press [TRIG] + [STOP] to select to where you want to paste the pattern and past it.
 - To clear, first press [PATTERN]. Then press [TRIG] + [PLAY] to select the pattern you wish to clear and clear it.

10.1.2 PATTERN CONTROL

Press [PLAY] to start the playback of a pattern. Press [STOP] to stop the playback of all tracks. The sound will be cut off, but effects like Delay will continue to be audible until the delay repeats have faded out. When the sequencer has stopped, quickly press [STOP] + [STOP] to stop playback of all tracks and get just a short fade out the send effects.

When a pattern is playing press [PLAY] to pause the playback. Press [PLAY] to resume the playback.

If a pattern contains more than 16 sequencer steps, the <PATTERN PAGE> LEDs will indicate this. When a pattern is playing, the currently active pattern page is shown with a flashing, <PATTERN PAGE> LED.

10.1.3 CHAINS

Chains are sequences that consist of more than one pattern. You can use chains to preselect and automate in what order you want your patterns to play.



You can create one chain and it can contain any pattern in bank A–H. The chain can consist of up to 64 patterns.

1. Press **[PTN]**, and then press **[FUNC]** + **[YES]** to open the chain creator screen.
2. Use the **[LEFT]/[RIGHT]** keys to select a bank (if you want to select a pattern from another bank than the current). Then press **[TRIG 1–16]** to select a pattern. Repeat until you have created the desired chain.
3. (Optional) Press **[FUNC]** + **[LEFT]** to delete the last pattern from the chain.
4. Press **[YES]** to confirm the pattern chain and close the chain creator screen. Press **[NO]** if you wish to cancel the pattern chain and close the chain creator screen.
5. Press **[PLAY]** to start the sequencer and play the chain. The chain will be looped once the final pattern of the chain has played.

To exit chain mode, select a pattern or song using the normal selection process.

There is also a legacy procedure for how you create chains that also can be used.

1. Press and hold **[PTN]** and then press a **[TRIG 1–16]** key to select the first pattern in the chain.
2. Release the **[PTN]** key and then press **[TRIG 1–16]** keys in the same order as you want the chained patterns to play. Keep a previous **[TRIG]** key pressed while you press the next one, the one after that and so on. You can press the same **[TRIG]** key again if you wish to add the pattern multiple times in a row. If you want to add a pattern from another bank, use the **[LEFT]/[RIGHT]** keys to select a bank and then press **[TRIG 1–16]** to select pattern.
3. Press **[PLAY]** to start the sequencer and play the chain. The chain will be looped once the final pattern of the chain has played.



Please note that the chain will be lost when you create a new chain or when you select a new pattern/song. Chains cannot be saved and will be lost when you switch the Digitakt II off.



- Chains can be created while the sequencer is running.
- You can also use MIDI program change messages from an external device to change patterns on the Digitakt II. For more information, please see "14.4.1 SYNC" on page 76.

10.2 EDITING A PATTERN

Digitakt II offers three main modes of input when creating or editing a pattern, GRID RECORDING mode, LIVE RECORDING mode, and STEP RECORDING mode. In these modes, two types of trigs can be entered: Note trigs and Lock trigs.

10.2.1 TRIG TYPES

A trig is a sequencer event that you can place when you want the sequencer to perform an action on the Digitakt II. There are two types of trigs that you can use, note trigs and lock trigs.

- **NOTE TRIGS** trigger presets or MIDI notes.
- **LOCK TRIGS** trigger parameter locks (but does not trigger notes). For more information, please see "10.8.1 PARAMETER LOCKS" on page 47.

Note trigs are indicated by red **[TRIG]** keys and lock trigs are indicated by yellow **[TRIG]** keys. Unlit **[TRIG]** keys indicate steps that does not contain any trigs. Read more about parameter locks in section "10.8.1 PARAMETER LOCKS" on page 47. Trigs are added differently in the sequencer, depending on whether GRID RECORDING, LIVE RECORDING, or STEP RECORDING mode is active.

10.2.2 GRID RECORDING MODE

GRID RECORDING is a method of composing where you use the [TRIG] keys to add trigs.

1. Press [RECORD] to enter GRID RECORDING mode. The [RECORD] key lights up red to indicate that GRID RECORDING mode is active.
2. Select the track to which you want to add trigs by pressing and holding [TRACK] and then one of the [TRIG] keys. A red [TRIG] key indicates the active track.
3. Place note trigs on the sequencer using the sixteen [TRIG] keys. To add a lock trig, press [FUNC] + [TRIG]. Quickly pressing the [TRIG] key of any of the trigs entered will remove the trig. Pressing a [TRIG] key and holding it slightly longer will prepare the trig for editing, rather than removing it.
4. Select another track, and add note trigs. Repeat the procedure for all the tracks you want to use.
5. Press [PLAY] to listen to the sequence.

Add micro timing to a note trig by pressing and holding the [TRIG] key while pressing [LEFT]/[RIGHT]. For more information, please see "10.4 MICRO TIMING" on page 45.

Set the retrig speed by pressing and holding the [TRIG] key while pressing navigating to TRIG PAGE 2 keys where you can make various retrig settings. For more information, please see "10.5 RETRIGS" on page 45, and "11.3 TRIG PAGE 2" on page 54.

If the pattern contains more than 16 steps, select the pattern page you want to edit by pressing the [PAGE] key. A fully lit <PATTERN PAGE> LED shows the active pattern page.

Press [RECORD] to exit the GRID RECORDING mode.



- If your pattern has more than one page you can easily select which page you want to edit. Press and hold [PAGE], and then press one of the [TRIG] keys that light up to select the active page for editing. You can also cycle through the pages with the [LEFT] and [RIGHT] keys. For more information, please see "10.7 PAGE SETUP MENU" on page 45.
- You also have the possibility to select which pages of your pattern you want the sequencer to play and loop. The selected pages are then looped on playback. In GRID RECORDING mode, press and hold [PAGE], and then press [TRIG 9–16] to select which patterns pages you want to play and loop. Green [TRIG] keys shows the selected pages. The [TRIG 9–16] keys corresponds to pattern page 1–8. For example, you have an eight page pattern and you want to play and loop page 1, 2, 5, and 7. To accomplish this, press and hold page and then press [TRIG 9, 10, 13, 15]. Press and hold [PAGE] and then press [NO] to resume normal playback of all pages in the pattern.
- You can use an external MIDI controller such as a keyboard to input NOTE and TRIG VELOCITY data when you are in GRID RECORDING mode Just press and hold a [TRIG] key, and then play a note on the external keyboard. On MIDI tracks, you can add up to a four note chord to every trig. The first note sets the TRIG VELOCITY value for all notes on the trig.
- Press [TRIG] + [YES] to preview a specific trig. The preview includes any parameter locks you have placed on that trig.
- If you use an external MIDI controller to record to the Digitakt II MIDI tracks, the sequencer receives data on the Auto MIDI channel and records on the active track. For more information, please see "14.4.3 CHANNELS" on page 78.
- All trigs of a track can be shifted forwards or backward on the sequencer. While in GRID RECORDING mode, hold down [FUNC] while pressing the [LEFT] or [RIGHT] arrow keys to perform the trig shift.

10.2.3 LIVE RECORDING MODE

LIVE RECORDING mode is the second method of adding trigs to the tracks. In this recording mode, the [TRIG] keys are played in real time to input trigs to the tracks. You can also use KEYBOARD mode to add note trigs chromatically. Additionally you can add velocity, retrigs, and changing presets using the TRIG modes. It is also possible to enter parameter locks in real time. Trigs input in LIVE RECORDING mode can be automatically quantized or not. Non-quantized trigs can be quantized after they are recorded, by using the QUANTIZE menu that is accessed by pressing [FUNC] + [TRIG]. For more information, please see "10.6 QUANTIZE MENU" on page 45.

1. Press and hold [RECORD], then press [PLAY] to enter LIVE RECORDING mode. (Press [PLAY] twice while keeping the [RECORD] key pressed to activate/deactivate automatic quantization.) The sequencer starts to play, and the [RECORD] key starts to flash red.

2. Enter trigs in real time by pressing the **[TRIG]** keys. If **KEYBOARD** mode is active, the pitch value of the note trig will be recorded according to which **[TRIG]** key is pressed for the active track. Any changes to **PARAMETER** page settings, using the **DATA ENTRY** knobs, will be recorded as parameter locks and add lock trigs where needed.
3. Press **[PLAY]** to exit **LIVE RECORDING** mode while keeping the sequencer playing. If **LIVE RECORDING** mode is active and **[RECORD]** is pressed, **GRID RECORDING** mode will be activated.
4. Press **[STOP]** to stop both recording and playback of the sequencer.

To exit **LIVE RECORDING** mode while keeping the sequencer playing, press **[PLAY]**.



You can use an external MIDI controller such as a keyboard to input **NOTE**, **TRIG VELOCITY**, and **TRIG LENGTH** data in **LIVE RECORDING** mode. Just play the notes on the external keyboard and they will be recorded by the sequencer. On MIDI tracks, you can add up to a four note chord to every trig. The first note sets the **TRIG VELOCITY** value for all notes on the trig. The last note that is released sets the **TRIG LENGTH** for all notes on the trig.

10.2.4 STEP RECORDING MODE

STEP RECORDING is a quick and straightforward method of placing trigs on the sequencer. In this recording mode, you insert notes by pressing the **[TRIG]** keys or an external MIDI controller. The sequencer then captures the note and automatically advances to the next step. There are two different modes available, **STANDARD** mode and **JUMP** mode.

STANDARD mode

1. Press **[RECORD]** + **[STOP]** to enter **STEP RECORDING** mode. The **[RECORD]** key starts to double-blink red. (Press **[STOP]** twice while keeping the **[RECORD]** key pressed to toggle between **STANDARD** and **JUMP** mode).
2. Press a **[TRIG]** key to select the active step to where you want to start to add note trigs. The active step is shown with a green **[TRIG]** key that double-blinks. (If positioned on an earlier placed trig, it inherits the light pattern of that trig). You can also use **[LEFT]**/**[RIGHT]** to select the active step or skip steps.
3. Press and hold **[FUNC]** and then press **[TRIG 1-16]** key to add a note trig on the corresponding track to the active step. The active step then automatically advances to the next step.

You also have the option to add note trigs chromatically on the selected active track.

4. Press **[TRK]** + **[TRIG 1-16]** to select the track to which you want to add trigs. A red **[TRIG]** key indicates the active track.
5. Press **[KEYBOARD]** to toggle the chromatic mode keyboard on
6. Press and hold **[KEYBOARD]** and then press any lit **[TRIG]** key to add a note trig with the corresponding note value to the selected step. The active step then automatically advances to the next step. You can use **[UP]**/**[DOWN]** to transpose the chromatic keyboard on the **[TRIG]** keys up or down in octaves.
7. To remove a trig or to add a rest (no trig), position the active step on the trig that you want to remove or add a rest to, and then press **[NO]**. The active step then automatically advances to the next step.
8. To add a parameter lock to a trig, press and hold a **[TRIG]** key, and then turn the **DATA ENTRY** knob that controls the parameter you want to lock and set it to the desired value. The graphics become inverted for the locked parameter, and the locked parameter value is displayed. The **[TRIG]** key of the locked trig blinks red (for note trigs) or yellow (for lock trigs) to indicate that the trig now contains a parameter lock.
9. Press **[RECORD]** to exit **STEP RECORDING** mode.

JUMP mode

In **JUMP** mode, the **LEN** parameter setting on the **TRIG PARAMETER** page controls the note length of the trigs you place, and advances the active step the same length. A **LEN** value of 1/16 adds a sixteenth note and advances the sequencer one step. 1/8 adds an eighth note and advances the sequencer two steps. 1/4 adds a quarter note and advances the sequencer four steps and so on. The **LEN** parameter is also parameter locked on every trig you place.



- Press [PLAY] to listen to the sequence while you are programming it. Press [STOP] to stop the sequencer and stay in STEP RECORDING mode.
- If you use an external MIDI controller, you must set it to send MIDI data on the Digitakt II's defined AUTO CHANNEL. For more information, please see "14.4.3 CHANNELS" on page 78.
- If you use an external MIDI controller, the trig's VEL (velocity) value is determined by the velocity sent from these and is parameter locked.
- If you press and hold [FUNC] while inputting notes from an external MIDI controller, the velocity is fixed and determined by the VEL parameter setting.
- If you press and hold [YES] while you place a trig with [TRIG] keys or an external MIDI controller, the trig length is locked to the time you press the [TRIG] keys or the external MIDI controller.
- If you add a new note trig on a previously placed note trig, any parameter locks previously placed on that trig remain as they were.
- In STEP RECORDING mode, to avoid accidental key presses, [FUNC] + [NO] does not reload the pattern. [FUNC] + [YES] does not save the pattern. Instead they work as described above.

10.3 SEQUENCER MENU (EUCLIDEAN MODE)

The Euclidean sequencer mode uses two separate pulse generators to generate events (trigs) that are placed as evenly spread out over the sequencer track as possible. In addition to this you can also set a Boolean logic operator to combine or subtract the trigs from the two pulse generators in different ways.

When you turn on Euclidean mode for a track, the [REC] button will turn blue indicating the mode is active, and the [TRIG] keys where the generated trigs are placed will also be blue. Any trigs placed on the sequencer before activating the Euclidean mode will be hidden and inactive while in this mode, but they'll reappear when you turn the mode off again. If you want to convert an Euclidean sequence into regular sequencer trigs, just press and hold [FUNC] while turning the Euclidean mode off. Any earlier placed trigs, while not in Euclidean mode, will be removed. While in Euclidean mode, it is not possible to add note trigs manually to the sequencer. However, you can still do parameter locking on the already generated trigs.

Press [FUNC] + [AMP] open the SEQUENCER menu.



PL1 Pulse generator 1 sets the number of pulses (trigs) placed on the sequencer by this generator.

PL2 Pulse generator 2 sets the number of pulses (trigs) placed on the sequencer by this generator.

LEN Track length sets how many steps the track will have. This parameter is only available in PER TRACK mode. For more information, please see "10.7 PAGE SETUP MENU" on page 45.

EUC Euclidean mode switches the Euclidean sequencer mode on/off.

RO1 Rotation generator 1 rotates the trigs placed by generator 1 forward or backwards on the track.

RO2 Rotation generator 2 rotates the trigs placed by generator 2 forward or backwards on the track.

TRO Track rotation rotates the trigs placed by both generator 1 and generator 2 forward or backwards on the track.

OP Boolean operator lets you add or subtract the trigs generated from the two pulse generators in different ways based on mathematical logical expressions.

OR all trigs from both generator 1 or 2 are placed the track.

XOR trigs from both generator 1 or 2 are placed on the track unless they are added to the same sequencer step.

AND only trigs added to the same sequencer step by generator 1 and 2 are placed on the track.

SUB trigs from generator 1 are placed on the track unless generator 2 adds a trig on the same step as generator 1.

10.4 MICRO TIMING

Here you can add micro timing to a note trig, moving it ahead or behind the beat. Micro timing can be customized on any of the sequencer steps on both audio and MIDI tracks. In GRID RECORDING mode, press and hold one or several **[TRIG]** keys and then press **[LEFT]/[RIGHT]** to access the pop-up Micro timing menu that shows the time offset for the chosen sequencer step(s) on the active track. Press **[LEFT]/[RIGHT]** to adjust the time offset. To exit the MICRO TIMING menu, release the **[TRIG]** key(s). The micro timing settings are stored in the active pattern.

For more information about the parameters on this page, please see "11.2 TRIG PAGE 1" on page 53



10.5 RETRIGS

Retrigs can be customized on any of the sequencer steps on the audio tracks (the retrigger function is not available on the MIDI tracks). In GRID RECORDING mode, press **[TRIG PARAMETERS]** twice to access the RETRIG PARAMETERS page. Hold one or several **[TRIG]** keys and then set the desired retrigger options for the trig(s).

For more information about the parameters on this page, please see "11.3 TRIG PAGE 2" on page 54.

10.6 QUANTIZE MENU

The quantization affects all micro timed and off grid trigs on the sequencers tracks. Press **[FUNC] + [TRIG PARAMETERS]** to access this menu. Change settings with **DATA ENTRY** knob **E** and **H**.

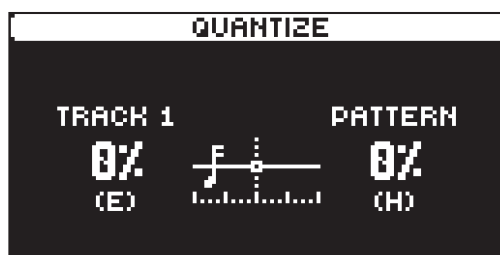

TRACK affects all the trigs of the active track in real time. The higher the quantize value, the more the trigs will be quantized. Press **[TRIG 1-16]** key to select track to quantize.

PATTERN affects all the trigs of all tracks in the pattern in real time. The higher the quantize value, the more the trigs will be quantized.

Press **[NO]** to exit the menu.

10.7 PAGE SETUP MENU

You can set the length and timing of the pattern and the tracks in this menu. The sequencer has up to 128 steps spread over 8 pages with 16 steps each. The PAGE SETUP menu has two modes. In PER PATTERN mode all tracks share the same length. In PER TRACK mode, each track can have different lengths. Press **[FUNC] + [PAGE]** to access the PAGE SETUP menu. Press **[FUNC] + [YES]** to toggle between the two modes. Use the **DATA ENTRY** knobs to adjust the settings.

10.7.1 PER PATTERN MODE

In this mode, all tracks of the pattern share the same length and time signature.

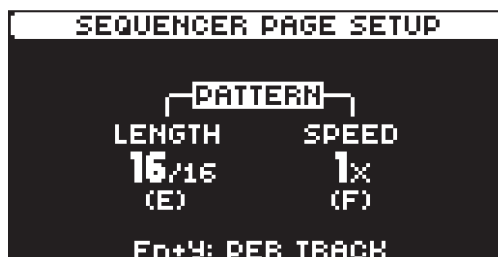

LENGTH sets the amount of steps on the current pattern page. The leftmost number displays the number of steps on the active pattern page. The total length, displayed by the second number, determines the maximum number of steps available in the pattern. If you use 17 steps or more in a pattern, the **[PAGE]** key is (while in GRID RECORDING mode) used to toggle between the different pattern pages.

SPEED controls the speed of pattern playback in multiples of the current tempo. It offers seven possible settings, 1/8X, 1/4X, 1/2X, 3/4X, 1X, 3/2X and 2X. A setting of 1/8X plays back the pattern at one-eighth of the set tempo. 3/4X plays the pattern back at three-quarters of the tempo; 3/2X plays back the pattern twice as fast as the 3/4X setting. 2X makes the pattern play at twice the BPM.

When you extend the length of a pattern, its trigs copies automatically over to the new steps. If a pattern consists of for example two pages and the pattern length is increased to four pages, the two additional pattern pages are then copies of the first two pattern pages.

Press the **[PAGE]** key repeatedly to change the total length of the pattern quickly. Press the **[TRIG]** keys to change the number of steps of the pattern quickly.

A 2X speed setting is useful for increasing the base resolution of the step sequencer to 32nd notes. A 3/4X setting is useful when Digitakt II is playing alongside other instruments set to the same BPM, and you want Digitakt II to play triplets.

10.7.2 PER TRACK MODE

In this mode, you can assign individual length and speed to the tracks of the pattern. Press **[FUNC] + [YES]** to switch between the two modes. In PER TRACK mode, two columns exist, TRACK and PATTERN.

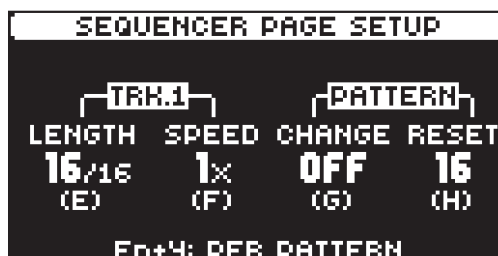

The TRACK column sets the step length and speed of the track. The settings only affects the active track.

The PATTERN column sets the master change length and the master length of the pattern.

LENGTH sets the amount of steps on the current pattern page. The leftmost number displays the number of steps on the active pattern page. The total length, displayed by the second number, determines the maximum number of steps available in the pattern. If you use 17 steps or more in a pattern, the **[PAGE]** key is (while in GRID RECORDING mode) used to toggle between the different pattern pages.

SPEED controls the speed of pattern playback in multiples of the current tempo. It offers seven possible settings, 1/8X, 1/4X, 1/2X, 3/4X, 1X, 3/2X and 2X. A setting of 1/8X plays back the pattern at one-eighth of the set tempo. 3/4X plays the pattern back at three-quarters of the tempo; 3/2X plays back the pattern twice as fast as the 3/4X setting. 2X makes the pattern play at twice the BPM.

CHANGE (Pattern Change) controls for how long the active pattern plays before it changes to a cued or chained pattern. This setting is important when, for example, you set **RESET** to INF. Then, if you do not make any **CHANGE** setting, the pattern plays infinitely and the next cued pattern will never play. By default a cued pattern change happens at the end of the pattern (**CHANGE** set to OFF).

RESET (Pattern Reset) controls the number of steps the pattern plays before all tracks resets and restarts from the first step on the first page. An INF setting makes the tracks of the pattern loop infinitely, without ever being restarted. Note that this setting also affects for how long the active pattern plays

before a chained pattern starts playing. The **CHANGE** parameter overrides this if its parameter value is less than the **RESETS** value.



In the **PAGE SETUP** menu, you can press **[FUNC] + [UP]/[DOWN]** to set the **TRACK LENGTH** in increments from 2/16 to 128/128.

10.8 SEQUENCER FEATURES

10.8.1 PARAMETER LOCKS

Parameter locks makes it possible to set every trig to have its own unique parameter values. The note trigs of an audio track can, for example, have different pitch, amp or filter settings. It is possible to parameter lock the parameters found on the **PARAMETER** pages, and you can apply parameter locks to all types of tracks. For a complete overview of all parameters on the **PARAMETER** pages, please see "11. TRACK PARAMETERS" on page 53, and "A.2.6 MIDI" on page 97.

Adding parameter locks in **GRID RECORDING** mode.

1. Press **[RECORD]** to enter **GRID RECORDING** mode.
2. Press a **[TRIG]** key to add a Note trig or **[FUNC] + [TRIG]** key to add a Lock trig and to where you want to perform a parameter lock.
3. Press and hold the **[TRIG]** key of a previously placed trig (note trig or a lock trig).
4. Turn the **DATA ENTRY** knobs that control the parameter you want to lock, and set it to the desired value. The graphics become inverted for the locked parameter, and the locked parameter value is displayed. The **[TRIG]** key of the locked trig blinks red (for note trigs) or yellow (for lock trigs) to indicate the trig now contains a parameter lock.

Remove a single parameter lock by holding **[TRIG]** + pressing the **DATA ENTRY** knob of the locked parameter. You can erase all parameter locks from a trig if you remove the note trig and then enter it again.

Adding parameter locks in **LIVE RECORDING** mode.

1. Press and hold **[RECORD]**, then press **[PLAY]** to enter **LIVE RECORDING** mode.
2. Turn a **DATA ENTRY** knob, or play the **[TRIG]** keys in **KEYBOARD** mode, to add parameter locks to the active track. Note trigs are placed, and parameter locked accordingly, and it also places lock trigs that contains the parameter locks on the sequencer steps that do not already have any trigs.

Press **[NO]** + one (or several) of the **[TRIG]** keys to erase a sequence of recorded trigs on a specific track (or on several tracks) in time with the sequencer, i.e. all steps reached on the pattern playing will be erased until the keys are released.

You can also remove specific parameter locks on a track in real time. In **LIVE RECORDING** mode, press and hold **[NO]** and then press and hold the **DATA ENTRY** knob corresponding to the parameter that you want to remove.

Adding parameter locks in **STEP RECORDING** mode.

1. Press and hold **[RECORD]**, then press **[STOP]** to enter **STEP RECORDING** mode.
2. Press and hold a **[TRIG]** key, and then turn the **DATA ENTRY** knobs that control the parameter you want to lock, and set it to the desired value. The graphics become inverted for the locked parameter, and the locked parameter value is displayed. The **[TRIG]** key of a locked trig blinks red (for note trigs) or yellow (for lock trigs) to indicate that the trig contains a parameter lock.



- Up to 80 different parameters can be locked in a pattern. A parameter counts as one (1) locked parameter no matter how many trigs that lock it. If for example the cutoff parameter of the filter is locked on every sequencer step, there are still 79 other parameters that can be locked.
- In **GRID RECORDING** mode, if you press and hold a trig that contains parameter locks, the **[PARAMETER]** page keys lights up in red to show where parameters with parameter locks applied resides.

10.8.2 PRESET LOCKS

You can change a track's preset to another preset from the pool on any individual sequencer step. These preset locks are an immensely useful feature for adding variations to a track. Press and hold a note trig and turn the **LEVEL/DATA** knob to open the pool list. Use the **LEVEL/DATA** knob to scroll through the list. Select the preset you want to assign to the note trig and then release the **[TRIG]** key. Press and hold the **[TRIG]** key of the note trig to show the assigned preset. For more information, please see "9.3.1

LOAD (PRESET)" on page 30. For more additional information, please see "9.1.1 ADDING PRESETS TO THE POOL" on page 29.

10.7.3 TRIG CONDITIONS AND CONDITIONAL LOCKS

Trig conditions are a set of conditional rules that you can apply to any trig, using specific parameter locks called conditional locks. Each rule is a logical condition that determines whether a trig set on a track in the sequencer is triggered or not. If the condition is true, then the trig will play. If the condition is false, the trig will not play.

ADDING A CONDITIONAL LOCK

1. In GRID RECORDING or STEP RECORDING mode, place a note trig or lock trig on the sequencer step to where you want to apply a conditional lock.
2. Press and hold the trig to access the **COND** (Trig Condition) parameter on the TRIG PAGE 1. For more information, please see "11.2 TRIG PAGE 1" on page 53.
3. Turn **DATA ENTRY** knob **H** to select one of the following trig conditions:

PRE is true and the trig plays if the most recently evaluated trig condition on the same track was true. (PRE and $\overline{\text{PRE}}$ conditions are ignored and not evaluated.)

$\overline{\text{PRE}}$ is true when PRE is false. A trig with this trig condition plays if the most recently evaluated trig condition on the same track was not true. (PRE and $\overline{\text{PRE}}$ conditions are ignored and not evaluated.)

Example 1: Trig 1, 50% = True > Trig 2, $\overline{\text{PRE}}$ = False > Trig 3, $\overline{\text{PRE}}$ = False > Trig 4, PRE = True

Example 2: Trig 1, 50% = False > Trig 2, $\overline{\text{PRE}}$ = True > Trig 3, $\overline{\text{PRE}}$ = True > Trig 4, PRE = False

NEI is true and the trig plays if the most recently evaluated trig condition on the neighbor track was true. (PRE and $\overline{\text{PRE}}$ conditions on the neighbor track are ignored and not evaluated.) The neighbor track is the track before the active track. For example, track 3 is the neighbor track of track 4. NEI and $\overline{\text{NEI}}$ conditional trigs on track 4 therefore evaluate the conditional trigs placed on track 3. The NEI condition is false if no conditional trigs exist on the neighbor track.

$\overline{\text{NEI}}$ is true when NEI is false. A trig with this trig condition plays if the most recently evaluated trig condition on the neighbor track was not true. (PRE and $\overline{\text{PRE}}$ conditions on the neighbor track are ignored and not evaluated.)

1ST The trig plays the first time the pattern plays (when looped).

$\overline{\text{1ST}}$ The trig does not play the first time the pattern plays (when looped).

LST The trig plays the last time the pattern plays before changing to another pattern.

$\overline{\text{LST}}$ The trig does not play the last time the pattern plays before changing to another pattern.

A:B A sets how many times the pattern (or track, if the track length is shorter than the pattern length) plays before the trig condition is true. B sets how many times the pattern (or track, if the track length is shorter than the pattern length) plays before the count is reset and starts over again. This cycle then repeats until you stop the sequencer.

For example:

With the setting 1:2, the trig plays the first time the pattern plays and then the third, the fifth, and so on.
With the setting 2:2, the trig plays the second time the pattern plays and then the fourth, the sixth, and so on.

With the setting 2:4, the trig plays the second time the pattern plays and then the sixth, the tenth, and so on.

With the setting 4:7 the trig plays the fourth time the pattern plays and then the eleventh, the eighteenth, and so on.

$\overline{\text{A:B}}$ is true when A:B is false. Meaning a trig with this condition plays when the set condition of pattern plays are not met.

For example:

With the setting $\overline{2:4}$, the trig does not play the second time the pattern plays and then the sixth, the tenth, and so on.



- The FILL trig condition has a separate parameter on TRIG PAGE 1. For more information, please see "11.2 TRIG PAGE 1" on page 53.
- The sequencer needs to be in FILL mode to activate the conditional lock called FILL. For more information, please see "10.8.4 FILL MODE" on page 49.
- Conditional parameter locks are a great way to add variety to a pattern. To set up a grid of mutually exclusive or conclusive note trigs across any of the tracks, and adding some probability locks in there as well (perhaps, in turn, also sporting an array of logically conditioned trigs), is a neat way to make the most minimal of compositions come alive with randomness.
- They may also be used, for example, to have two different melodic or percussive sequences on the same track, one of which is activated only when FILL mode is active.

10.8.4 FILL MODE

FILL mode can be used to create a temporary variation, such as a drum fill, in your pattern.

Press [YES] + [PAGE] to activate FILL mode for one pattern cycle. It will become active when the pattern loops, and remain active until it loops again. You can also activate FILL mode at any time, and for any duration, by pressing and holding the [PAGE] key when the pattern is playing (GRID RECORDING mode cannot be active). The FILL mode is active for as long as the key is held.

Press and hold [PAGE] + [YES], and then release [PAGE] before you release [YES] to latch FILL mode. Press [PAGE] again to unlatch FILL mode.

10.8.5 COPY, PASTE AND CLEAR OPERATIONS

Patterns, tracks, track pages, parameter pages, and trigs can be copied, pasted and cleared.

The active pattern can be copied to another location in the same bank or in another bank. To perform a pattern copy operation, GRID RECORDING mode must be deactivated. Copy the pattern by pressing [FUNC] + [RECORD]. Select another pattern, and then press [FUNC] + [STOP] to paste the copied pattern to this location. Press [FUNC] + [PLAY] to clear all the trigs in the current pattern.

Individual sequencer tracks can be copied, pasted and cleared in the same way as patterns. To do so, GRID RECORDING mode must be active.

A single track page may also be copied, pasted and cleared. It is similar to copying/pasting/clearing a track, but will only affect the active track page. Select the track page of choice by pressing the [PAGE] key. Copy by pressing [PAGE] + [RECORD]. Select a new track page and press [PAGE] + [STOP] to paste. Press [PAGE] + [PLAY] to clear the active track page.

A single parameter page with all its settings may also be copied, pasted and cleared. Select the parameter page you wish to copy by pressing a [PARAMETER] key. Copy by pressing [PARAMETER] + [RECORD]. Select a new track and then press the same [PARAMETER] page + [STOP] to paste. Press [PARAMETER] + [PLAY] to clear the parameter page.

Trigs, complete with all parameter lock settings, can be copied, pasted and cleared as well. GRID RECORDING mode needs to be active to access this functionality. Press and hold a trig and press [RECORD] to perform the copy operation. Paste by holding another [TRIG] key and pressing [STOP]. It is also possible to copy more than one trig. Press and hold the trigs you wish to copy, and then press [RECORD]. Press and hold the [TRIG] key to where you want to paste, and then press [STOP] to paste the copied sequence of trigs. When pasting, the copied trigs are placed in the same relation to each other as they had when they were copied. The destination trig acts as the starting point for the sequence of copied trigs. Clear trig locks by holding one or more trigs and press [PLAY].

You can undo any copy, paste, and clear operation by repeating the key presses.



It is possible to copy, clear and paste one or several patterns without leaving the active pattern. First press [PTN], then press [TRIG] + [RECORD] to select the pattern you wish to copy and copy it. Then press [TRIG] + [STOP] to paste the copied pattern to where you wish to paste it. Press [TRIG] + [PLAY] to clear the selected pattern.

10.8.6 TEMPORARY SAVE AND RELOAD PATTERN COMMANDS

Patterns can instantly be saved to a temporary memory space and then reloaded again from this space.

- To perform a temporary save of the active pattern, press [FUNC] + [YES]. This is useful in order to create a restore point when you are live tweaking, but without permanently save your changes.
- To perform a temporary reload of the active pattern, press [FUNC] + [NO]. It will reload the pattern from when you last used the temporary save command. If you have not done any temporary save, then the pattern will reload from the permanently saved state.



The **TEMPORARY SAVE PATTERN** and **TEMPORARY RELOAD PATTERN** commands are great when improvising live. Any changes made to the active pattern, like adding bass line notes or using **CONTROL ALL**, can immediately be undone. And at the same time, the saves and reloads will not affect the pattern in a permanent way.



The **TEMPORARY SAVE PATTERN** command will not save the pattern permanently and any changes will be lost if you load another project. If you wish to save your changes permanently, you should use **SAVE TO PROJ** in the **PATTERN MENU**. For more information, please see "14.3 PATTERN MENU" on page 75.

10.9 SONG MODE

A song is an arrangement of patterns set up to play in sequence. Each row in the SONG mode arrangement can have separate settings for pattern, row repeat, row length, tempo, and mute. A song can be up to 99 rows in length, and each project can contain up to 16 songs.

10.9.1 THE SONG EDIT SCREEN

Press **[SONG]** and then press **[TRIG 1-16]** to select a song and enter SONG mode. Press **[FUNC] + [SONG]** to open the SONG EDIT screen. Use the **[ARROW]** keys to navigate the song rows and columns, highlighting the parameter you wish to edit, and then use **LEVEL/DATA** or any **DATA ENTRY** knob to edit the selected function.

#	LABEL	PTN	🔄	+1	🔊	🔇
01	INTRO	AD3	4	016	120.0	
02	VERSE	B12	2	064	120.0	🔇
03	BRIDGE	AD5	1	032	110.0	🔇
04	CHORUS	CD1	2	064	120.0	
05	VERSE	B12	2	032	120.0	
-	END:	STOP				

- SONG ROW** (Range 01-99)
- LABEL** lets you select a keyword for the row. The keyword is related to song structure, e.g., Verse, Chorus, and Fill. It can also be the name of the pattern.
- PTN** lets you select the pattern to be played on the row. Press **[FUNC]** while turning the knob to change banks quickly.
- ROW PLAY COUNT** The number of times the row plays before the song advances to the next row.
- ROW LENGTH** (measured in sequencer steps). This setting defines how many steps the sequencer plays from the selected pattern. The default value is the same as the pattern length. (Range: 2-1024, the last 25 values are written as K00-K24)
- ROW TEMPO** Here, you set the row's BPM per row. You can also choose to have one BPM for the whole song. By default, the row inherits the BPM and swing set in the pattern selected for the row. Press **[TEMPO]** to open the TEMPO menu for the currently selected row's pattern. Here you can also set the swing. You can also press **[YES]** while highlighting the BPM parameter to open the TEMPO menu. Selecting song tempo on any row overrides all the previously set row and pattern tempos. The swing settings are always set per row.
- SONG POINTER** Shows the current time and position of the playhead in the song arrangement.
- ROW MUTE** lets you mute the tracks of the pattern on the selected row. Highlight and press **[YES]** to edit. A mute icon is displayed in the rows that have tracks that are muted. Use the **[TRIG]** keys to mute and unmute the tracks. When selecting a pattern for the row, the row's mute state initially reflects the pattern's mute state
- END row.** This row is always added at the end of a song and determines what will happen when the song has played the last song row. By default, it is set to LOOP the song from the beginning and play it again, but it can also be set to STOP the song.
- The currently selected row is highlighted between dotted lines. Use **[UP]** and **[DOWN]** to select row.
- PLAYHEAD** position shows the row currently playing (or set to play if the sequencer is stopped).
- SONG SLOT** and **SONG NAME.**

10.9.2 CREATING AND EDITING A SONG

1. Press [SONG] and then press [TRIG 1-16] to select a song and enter SONG mode.
2. Press [FUNC] + [SONG] to open the SONG EDIT screen.
3. If you selected an empty song slot, you are presented with a screen where you can choose:
 - INSERT ROW** Inserts the first row in the song. Press [FUNC] + [DOWN] to insert a row.
 - CREATE ROWS FROM CHAIN** Creates a song based on a chain. Press [YES] and then select to create rows from a previously created chain or to create a new chain by selecting patterns using the [TRIG 1-16] keys. Use [LEFT]/[RIGHT] to change bank. Then press [YES] to create a song based on the chain and open the SONG EDIT screen.
4. Press [FUNC] + [DOWN] if you want to add a new row to the song arrangement. The new row is added below the currently selected row and is a copy of the selected row. Press [FUNC] + [UP] to remove the selected row from the song arrangement.
5. Use the [ARROW] keys to navigate the song rows and columns, highlighting the item you wish to edit. For more information about editing the functions in SONG mode, please see "10.9.1 THE SONG EDIT SCREEN" on page 50.
6. To rename the song, navigate to SETTINGS > SONG > RENAME, and then edit the song name.
7. Press [NO] or [FUNC] + [SONG] to exit the SONG EDIT screen.



- [FUNC] + [RECORD] copies the selected row.
- [FUNC] + [STOP] pastes a previously copied row to the selected row.
- [FUNC] + [PLAY] resets the selected row to the pattern's default BPM, length, and mute state settings.
- [FUNC] + [UP] deletes the selected row.
- Please note that there is always a row called END at the song's end. This row can be set to either STOP the song or LOOP it from the beginning and play it again.
- On the SONG EDIT screen, you can select a song row number and then press YES to move the playhead to this row. You can also use the [TRIG 1-16] keys to preview and play the track presets from the pattern on the playhead row.

10.9.3 PLAYING A SONG

1. Press [SONG] and then press [TRIG 1-16] to select a song and enter SONG mode. The song selected will be the one that was last played or edited.
2. Press [PLAY] to play the selected song. At the top of the screen, you see the song number, the row currently playing, the total number of rows in the song, the row's LABEL, and finally the patterns bank/number. This part of the screen is also used as a progress bar to show how far in the row the song pointer has progressed.



3. Press [STOP] to stop the playback. You can then press [PLAY] to continue to play the song from the current playhead position. Press [STOP] twice to move the playhead to the song's beginning.
4. Select a pattern to exit SONG mode.



- Press [SONG MODE] + [LEFT] (when in SONG mode) to loop the currently playing row. Press [SONG MODE] + [LEFT] again (when in SONG mode) to stop looping the row and return to normal song playback.
- Press [SONG MODE] + [UP]/[DOWN] (when in SONG mode) to select a specific song row to jump to and to play next.
- Press [PTN] and the [TRIG 1-16] keys to select a pattern to exit SONG mode and return to regular pattern play.



The songs are automatically saved as they are created and edited. However, you must save the project if you wish to keep the songs before switching to another project.

10.10 PERFORM KIT MODE

In PERFORM KIT mode, any changes made to the preset parameters are not auto-saved, and kits are not loaded when you change the pattern; instead, you keep the previous (tweaked) kit. It means you can keep your parameter tweaks over several patterns and have a smooth evolving performance without having the kits reloaded or inadvertently saving your kit when you change patterns.

Press [FUNC] + [PRESET/KIT] to toggle PERFORM KIT mode on/off. When PERFORM KIT mode is on, a flashing "P" is shown next to the pattern name on the screen.



10.10.1 PERFORM KIT MODE ACTIONS

- Press [PRESET/KIT] + [NO] to reload the current patterns kit instantly.
- Press [PRESET/KIT] + [YES] to save the current patterns modified kit. This will open the SAVE (KIT) menu. For more information please see "9.3.6 SAVE (KIT)" on page 34.



Pattern Temp save and Temp reload still works while in PERFORM KIT mode



Actions done in PERFORM KIT mode are not automatically saved and will not remain when switch the device off. If you want to keep any changes done to the patten permanently, the pattern must be saved

11. TRACK PARAMETERS

Here follows a description of all of the parameters that are available on the audio tracks **PARAMETER** pages. The parameters on the **TRIG** page are not saved together with the preset, but are instead saved with the pattern. The track parameters may be locked to other settings on any step of the pattern by first pressing and holding a **[TRIG]** key, then changing the parameters' settings with the **DATA ENTRY** knobs. For more information, please see "10.8.1 PARAMETER LOCKS" on page 47.



Please note that MIDI tracks has a different set of parameters on the **TRIG**, **SRC**, **FLTR**, and **AMP** page. For more information, please see "A.2.6 MIDI" on page 97.

11.1 EDITING THE TRACK PARAMETERS

There are six **PARAMETER** pages for the tracks. Press the **[PARAMETER]** keys to access the tracks **PARAMETER** pages. Use the **[UP]/[DOWN]** keys to cycle through the parameter group's pages. You can also press a **[PARAMETER]** key repeatedly to cycle through the parameter pages in that group. Press and hold a **[PARAMETER]** key to see the values for all parameters on that page.



- You can always reload a preset from its last saved state. Press **[TRK] + [TRIG 1-16] + [NO]** to reload the preset.
- You can also randomize the parameter settings on a specific **PARAMETER** page on an audio track. Press **[PARAMETER]** key + **[YES]** to randomize the relevant parameters on that page. Every time you press this key combination, the parameters randomize in a new way.
- Press **[PARAMETER]** key + **[NO]** to reset the **PARAMETER** page to its last saved state.

11.2 TRIG PAGE 1

Here you set the options for notes that are triggered. Here you also select trig conditions. Press the **[TRIG PARAMETERS]** key to access the menu. Change settings using the **DATA ENTRY** knobs. These general settings affect note trigs placed on the sequencer. Trigs can be locked to other settings on any step of the pattern by first pressing and holding a **[TRIG]** key, then changing the settings.

Press **[TRIG PARAMETERS]** to access this parameter page.

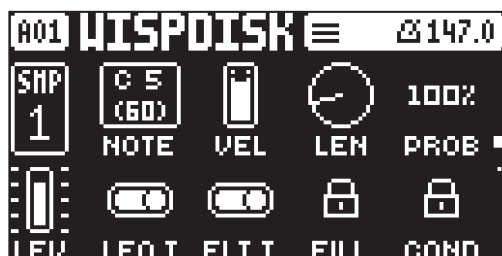

NOTE

Trig Note sets the pitch of the note when triggered. When in **LIVE RECORDING** mode and playing in **KEYBOARD** mode, the pitch of the **[TRIG]** keys played will override this setting. Press and turn **DATA ENTRY** knob **A** to select only note values that exist in the scale set by **KB SCALE**. For more information, please see "8.5.2 KEYBOARD SETUP MENU" on page 25.

VEL

Trig Velocity sets the velocity of the sequencer's note trigs.

LEN

Trig Length sets the length of the note trig. In **LIVE RECORDING** mode, the duration of pressing the **[TRIG]** keys overrides this general setting.

PROB

Trig Probability sets the probability that the trigs on the track plays or not. The probability outcome is re-evaluated every time a trig is set to play. The default setting is 100%, meaning that all the trigs on the track plays every time. This parameter can be parameter locked which lets you give separate trigs their own probability.

LFO.T

LFO Trig controls if the LFO will be triggered or not.

FLT.T

Filter Trig controls if the filter envelope will be triggered or not.

FILL

Fill is a separate trig condition that determines if a trig is active (plays) or not depending on if the device is in FILL mode or not. For more information, please see "10.8.4 FILL MODE" on page 49, and "10.7.3 TRIG CONDITIONS AND CONDITIONAL LOCKS" on page 48.

ON A trig with FILL set to ON, plays when FILL mode is active.

OFF A trig with FILL set to OFF plays when FILL mode is not active.



The sequencer needs to be in FILL mode to activate the FILL trig condition. For more information, please see "10.8.4 FILL MODE" on page 49.

COND

(Trig Condition) when you add a conditional lock. **COND** sets the Trig Condition with which a set of conditional rules can be applied to any trig, using a conditional parameter lock. For more information, please see "10.7.3 TRIG CONDITIONS AND CONDITIONAL LOCKS" on page 48.

11.3 TRIG PAGE 2

Here you set the behavior of retrigs that are added to note trigs placed in the sequencer. On this page you also control the portamento. Change settings using the **DATA ENTRY** knobs. These general settings all affect note trigs placed in the sequencer.

Retrigs can be customized on any of the sequencer steps on the audio tracks (the retrigger function is not available on the MIDI tracks). In GRID RECORDING mode, press [**TRIG PARAMETERS**] twice to access the RETRIG PARAMETERS page. Hold one or several [**TRIG**] keys and then set the desired retrigger options for the trig(s). The RETRIG PARAMETERS page shows the retrigger actions for the chosen sequencer step(s) on the active track. The retrigger settings are stored in the active pattern.



RTRG

Retrig turns the retrigger lock ON/OFF. Use **DATA ENTRY** knob **A** to turn retrigger on/off. For information on setting retrigger locks on specific trigs in the sequencer, please see "10.5 RETRIGS" on page 45.

VFAD

Velocity Fade sets the velocity curve fade out/fade in of the retrigger (-64–64). -64 corresponds to a complete fade out during the set length, -32 fades out to half the velocity during the set length, 0 equals a flat velocity curve with no fade, 32 fades into half velocity during the set length and 64 fades in completely to full velocity during the set length. Please note that the effects of the **VFAD** setting is also dependent on the **VEL** setting on TRIG PAGE 1.

LEN

Length sets the duration of the retrigger velocity curve in fractions of, or rational or integer multiples of, a step (0,125–INF). 1/16 is the nominal length of one step. This setting affects the behavior of the velocity curve by defining the boundaries of its envelope.

RATE

Rate sets the retrigger rate (1/1, 1/2, 1/3, 1/4, 1/5, 1/6, 1/8, 1/10, 1/12, 1/16, 1/20, 1/24, 1/32, 1/40, 1/48, 1/64 or 1/80). 1/16 is the nominal retrigger rate, one trig per step. 1/32 corresponds to two trigs per step and so on. To trig triplets, for example, set the retrigger rate to 1/12 (or 1/24).

PTIM

Portamento Time sets the time for the portamento.

PORT

Portamento turns the portamento on/off. Please note that this parameter is only available on audio tracks.

For more information, please see "9.8.2 TRACK" on page 37.

11.4 SRC PAGE

The parameters on the SOURCE pages control the playback of the samples, and these parameters vary depending on what machine is selected. The SRC machines are sound engines that use a particular subset of the functionality of the sample playback engine. In this section you also find the MIDI machine that lets you control external, MIDI equipped, gear. You can assign any SRC machine to any track. SRC page 2 contains the same parameters as on page 1 but with a graphical representation of the parameters and a view of the sample waveform. For more information, please see "A.2 SRC MACHINES" on page 91.

Use the *DATA ENTRY* knobs to change the settings.

Press [SRC] to access this parameter page.

11.5 FLTR PAGE 1

The parameters on the FLTR page 1 control the filter/EQ, and these parameters vary depending on what machine is selected. The FLTR machines are a collection of different filters and EQ. For more information, please see "A.3 FLTR MACHINES" on page 100.

Use the *DATA ENTRY* knobs to change the settings.

Press [FLTR] to access this parameter page.

11.6 FLTR PAGE 2

On FILTER page 2, you will find the parameters that control the base-width filter and the envelope delay parameter.

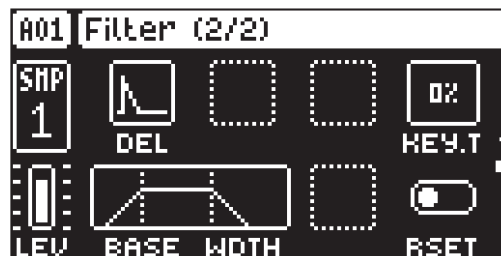

The base-width filter is basically a Highpass filter and a Lowpass filter connected in series. The filters **BASE** and **WIDTH** parameters define the base-width filter's frequency range.

Examples of how the **BASE** and **WIDTH** parameters affect the filter frequency range:

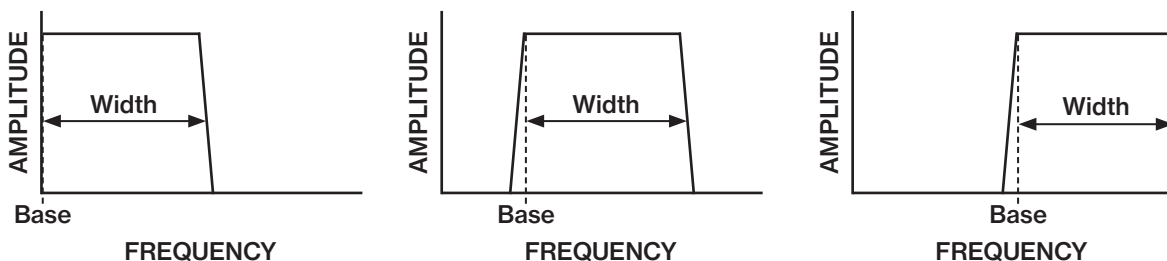

- With **BASE** set to 0, the filter functions as a low pass filter with **WIDTH** adjusting the frequency range.
- With **WIDTH** set to 127, the filter functions as a high pass filter with **BASE** adjusting the frequency range.
- With **BASE** set to 0 and **WIDTH** set to 127 the filter does not affect the sound.

DEL

Envelope delay sets the time before the attack phase of the filter envelope starts. This parameter is part of the filter envelope that controls the multimode filter. You can also press and hold [FUNC] and then turn *DATA ENTRY* knob A to quickly access this parameter from FILTER page 1.

KEY.T

Keytrack sets how much the filter cutoff frequency is affected by what note is playing. The higher the KEY.T setting, the more the filter opens up at higher notes.

BASE

Sets the base frequency of the filter.

WIDTH

Sets the frequency width above the base frequency.

RSET

Filter Envelope reset sets the filter envelope behavior:

- ON resets the envelope for each consecutive trig (default).
- OFF does not reset the envelopes for each consecutive trig.

11.7 AMP PAGE

The AMP page controls parameters for the amplitude envelope, panning, and volume.

Press [AMP] to access this parameter page.



ATK

Attack Time sets the length of the attack phase of the amp envelope.

HOLD

Hold Time sets the length of the hold phase of the amp envelope. Fixed Hold time values (0–126) specify the length of the hold phase, and the envelope ignores Note Off events such as Trig Length, releasing a [TRIG] key or a key on an external controller. Setting **HOLD** to NOTE means the hold phase will be determined by Note On and Note Off events. This parameter is only available if **MODE** on is set to AHD.



If you set **HOLD** to NOTE and use an external keyboard to trigger the envelope, then the sound will be sustained (if DEC is set to less than 127) for as long as you press a key on the keyboard.

DEC

Decay Time sets the length of the decay phase of the amp envelope.

SUS

Sustain Level sets the sustain level of the amp envelope. This parameter is only available if **MODE** on is set to ADSR.

REL

Release Time sets the length of the release phase of the amp envelope. This parameter is only available if **MODE** is set to ADSR.

RSET

Amp envelope reset sets the amp envelope behavior:

ON resets the envelope for each consecutive trig (default).

OFF does not reset the envelope for each consecutive trig.

MODE

Envelope mode sets the amplitude envelope to function as an AHD or an ADSR envelope.

PAN

Pan positions the audio in the stereo field.

VOL

Volume sets the volume amount of the amplifier. Unlike the track **LEVEL**, this parameter can be parameter locked.

Amplitude envelope with **MODE** set to AHD and a fixed **HOLD** time.

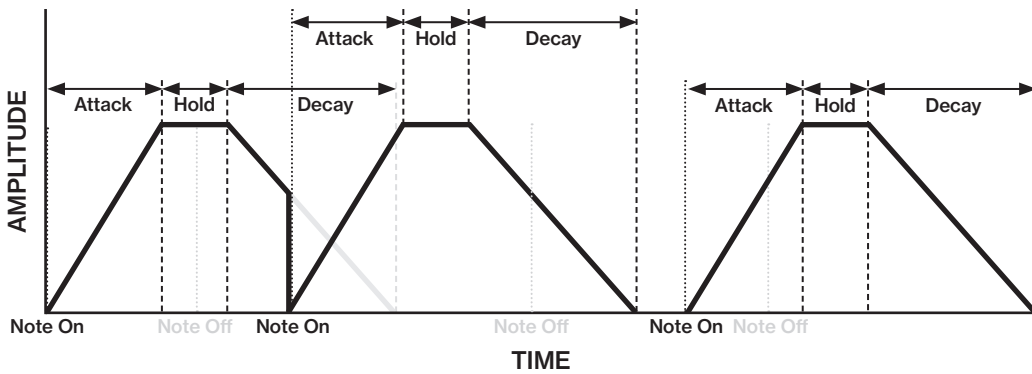

Amplitude envelope with **MODE** set to AHD and **HOLD** set to NOTE.

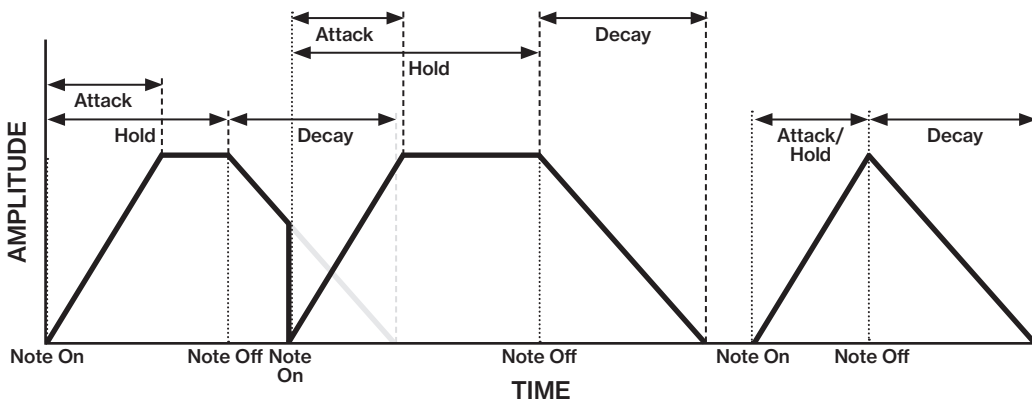

11.8 FX PAGE

The FX parameter page contains a number of FX related parameters such as the Bit Reduction, Overdrive, and Sample Rate Reduction. Here you also find the send levels for the Delay, Reverb, and Chorus effects.

Press [FX] to access this parameter page.



BR

Bit Reduction sets the bit rate. The parameter range is from 16 bits to 1 bit.

OVER

(Overdrive) sets the gain amount into the digital overdrive.

SRR

Sample Rate Reduction sets the amount of sample rate reduction.

ROUT

SRR Routing sets if the Sample Rate Reduction effect is applied pre (before) or post (after) the filter section.

DEL

Delay Send sets the amount of sound sent through to the Delay effect. For more information, please see "12. FX AND MIXER PARAMETERS" on page 61.

REV

Reverb Send sets the amount of sound sent through to the Reverb effect. For more information, please see "12. FX AND MIXER PARAMETERS" on page 61.

CHR

Chorus Send sets the amount of sound sent through to the Chorus effect. For more information, please see "12. FX AND MIXER PARAMETERS" on page 61.



Please note that there are no parameters on the FX page for MIDI tracks.

11.9 MOD PAGE 1

The MOD pages contains three LFOs (two for tracks that use MIDI machines). The Low-Frequency Oscillator can be used to modulate the parameters found on the tracks SRC, FILTER and AMP pages. Customize the low-frequency oscillator behavior, orientation, and depth on this page. This page controls the behavior of LFO 1

Press [MOD] to access this parameter page.



SPD

Speed sets the speed of the LFO. Try settings of 8, 16 or 32 to sync the LFO to straight beats. The knob is bipolar. The LFO cycle can be played backward by using negative values.

MULT

Multiplier multiplies the SPD parameter by the set factor either by multiplying the current tempo (BPM settings), or by multiplying a fixed tempo of 120 BPM.

FADE

Fade In/Out makes it possible to fade in/fade out the LFO modulation. The knob is bipolar. Positive values give a fade-out, negative values give a fade in. 0 gives no fade in/fade out. (-64-63)

DEST

Destination selects the modulation destination for the LFO. Preview how the LFO modulation will affect the sound by highlighting a destination. Press [YES] to confirm the selection. For more information, please see "APPENDIX C: LFO MODULATION DESTINATIONS" on page 109

WAVE

Waveform sets the LFO waveform. The Triangle, Sine, Square, Sawtooth, and Random waveforms are bipolar. The Exponential and Ramp are unipolar.

SPH

Start Phase sets the point within the wave cycle where the LFO will start when it is triggered. 0 makes the LFO start at the beginning of a complete wave cycle, 64 makes it start at the center. A small square at the start of the waveform shows that the wave cycle starts at a zero-crossing. If **WAV** is set to RND then the **SPH** parameter changes to **SLEW** and adds slew to the transitions in the waveform.

MODE

Trig Mode sets how the LFO will act when a note is triggered.

- **FRE** is the default free-running mode. It makes the LFO run continuously, never restarting or stopping even if notes are triggered..
- **TRG** makes the LFO restart when a note is triggered.
- **HLD** makes the LFO run free in the background, but when a note is triggered the LFO output level is latched and held still until the next note is triggered.
- **ONE** The LFO starts when a note is triggered, then runs to the end of the waveform and then stops. This makes the LFO function similar to an envelope.
- **HLF** The LFO starts when a note is triggered, then runs to the middle of the waveform and then stops.

DEP

Depth sets the depth and polarity of the LFO modulation. Both negative (inverted) and positive modulation depth is possible. A center setting, 0.00, equals no modulation depth.

11.10 MOD PAGE 2

MOD page 2 page contains the same parameters as LFO page 1, but controls the behavior of LFO 2.

11.11 MOD PAGE 3

MOD page 3 page contains the same parameters as LFO page 1, but controls the behavior of LFO 3.



Please note that MIDI tracks only have two LFOs.

LFO waveforms and trig modes.

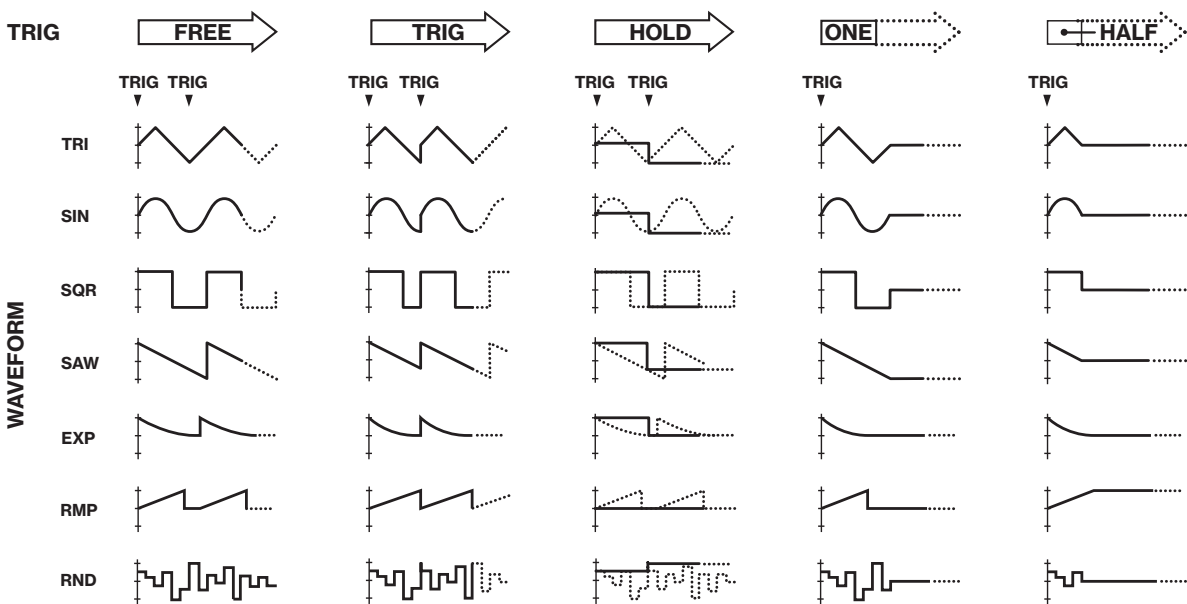

11. TRACK PARAMETERS

The table below shows the LFO speed measured in whole note values. One whole note equals 16 sequencer steps in 4/4 with SCALE set to 1x. I.e., a combination of SPD and MULT (set to a BPM value) settings that generate a value of 1 in the table gives that the LFO will do one full cycle in the time it takes the sequencer to advance 16 steps.

		MULT											
		1	2	4	8	16	32	64	128	256	512	1K	2K
SPD	1	128	64	32	16	8	4	2	1	1/2	1/4	1/8	1/16
	2	64	32	16	8	4	2	1	1/2	1/4	1/8	1/16	1/32
	4	32	16	8	4	2	1	1/2	1/4	1/8	1/16	1/32	1/64
	8	16	8	4	2	1	1/2	1/4	1/8	1/16	1/32	1/64	1/128
	16	8	4	2	1	1/2	1/4	1/8	1/16	1/32	1/64	1/128	1/256
	32	4	2	1	1/2	1/4	1/8	1/16	1/32	1/64	1/128	1/256	1/512
	64	2	1	1/2	1/4	1/8	1/16	1/32	1/64	1/128	1/256	1/512	1/1024

12. FX AND MIXER PARAMETERS

The Digitakt II effects and mixers parameters are explained in this chapter.

12.1 EDITING THE SEND FX AND MIXER PARAMETERS

The Digitakt II's Chorus, Delay and Reverb are send effects and are set on a pattern level. It means that all the presets in a pattern shares the same effect settings but have individual send levels to the effects. The Delay, Reverb, and Chorus parameters are set on their respective PARAMETER page, but their incoming signals are set by the DEL, REV, and CHO send parameters on the FX page of each audio track.

Press [FUNC] + [FX] to access the SEND FX parameter pages, and then use the [UP]/[DOWN] keys to navigate between the sub pages. Use the *DATA ENTRY* knobs A-H to change the parameters.

Press [FUNC] + [MOD] to access the MIXER parameter pages, and then use the [UP]/[DOWN] keys to navigate between the sub pages. Use the *DATA ENTRY* knobs A-H to change the parameters.



The FX and MIXER parameter settings are stored as part of the pattern. Don't forget to save the pattern and give it a unique name once you have achieved the results you want.

12.2 DELAY

(SEND FX PAGE 1)

The Delay send effect takes the input signal, delays it in time and then rejoins it with the original signal.



TIME

Delay Time sets the delay time. It is relative to the current BPM and is measured in 128th notes.

TIME setting	Divide ratio
1	1/128
2	1/64
2.67	1/48 (1/32T)
3	1/64.
4	1/32
5.33	1/24 (1/16T)
6	1/32.
8	1/16
10.67	1/12 (1/8T)
12	1/16.
16	1/8
21.33	1/6 (1/4T)
24	1/8.
32	1/4
42.67	1/3 (1/2T)
48	1/4.
64	1/2
96	1/2.
128	1

X

Ping-pong sets the delay signal to alternate across the stereo field. There are two settings:

- **OFF** lets you manually set the position of the delay signal in the stereo field. Use the **WID** parameter to change the stereo field position.
- **ON** makes the delay signal alternate between left and right pan positions. The **WID** parameter controls the amount of panning.

WID

Stereo Width sets the delay signal pan width across the stereo field. The knob is bipolar.

FDBK

Feedback Gain sets the amount of delay output signal to feed back into the input of the delay. With higher parameter settings, infinite and/or swelling delays are possible. Please be aware that high feedback can lead to a very loud signal.

VOL

Delay Volume sets the volume of the Delay output signal. Use **LEVEL/DATA** to set this parameter.

HPF

HPF sets the cutoff frequency of the delay highpass filter.

LPF

LPF sets the cutoff frequency of the delay lowpass filter.

REV

Reverb Send sets the amount of Delay output signal to be sent to the Reverb.

12.3 REVERB

(SEND FX PAGE 2)

The Reverb send effect controls the persistence, and ambient characteristics, of the sound reverberations. It can simulate many different sonic locations, from huge spaces to small rooms.

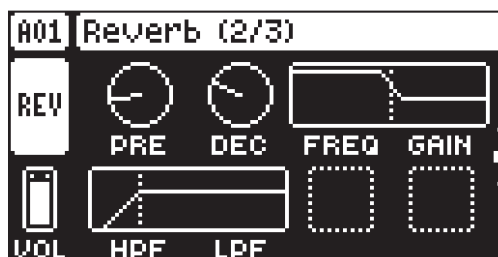

PRE

Pre-delay sets the pre-delay time of the Reverb.

DEC

Decay Time sets the length of the decay phase of the reverberated signal, essentially setting the size of the acoustic space.

FREQ

FB Shelving Freq sets the shelving filter frequency. Together with the **GAIN** parameter, it can be used to dampen the reverberated signal above a chosen frequency, making the reverberation sound more prominent or more muffled.

GAIN

FB Shelving Gain affects the damping of the reverberated signal above the shelving frequency set by the **FREQ** parameter. At max value the treble is included in the reverberations; lowering the value gradually dampens it.

VOL

Reverb Volume sets the volume of the Reverb output signal. Use **LEVEL/DATA** to set this parameter.

HPF

HPF sets the cutoff frequency of the reverb high-pass filter that affects the audio going in to the reverb.

LPF

LPF sets the cutoff frequency of the reverb low-pass filter that affects the audio going in to the reverb.

12.4 CHORUS

(SEND FX PAGE 3)

The chorus can be used to widen sounds, enhance the stereo image or add subtle movement to sounds.

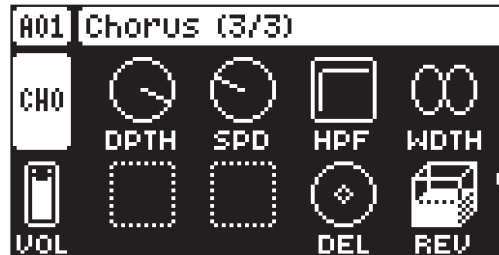
**DPTH**

Depth sets the depth of the LFO modulation of the chorus.

SPD

Speed sets the speed of the LFO modulation of the chorus.

HPF

High-pass filter sets the highpass filtering of the input signal.

WDTH

Width sets the stereo width of the chorus.

VOL

Chorus Volume sets the volume of the Chorus output signal. Use *LEVEL/DATA* to set this parameter.

DEL

Delay Send sets how much of the wet chorus signal to send through to the delay.

REV

Reverb Send sets how much of the wet chorus signal to send through to the reverb.

12.5 COMPRESSOR

(MIXER PAGE 1)

The Compressor master effect compresses the dynamic range of the signal by reducing the volume of loud sounds relative to the quiet sounds. There are eight parameters with which the compressor is customized on this page. There is a bar on the left side of the screen that visually represents the amount of compression.

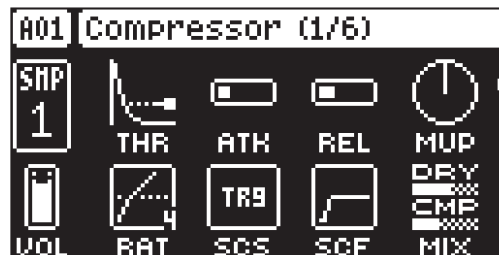

THR

Threshold sets the threshold of the compressor. A lower threshold means a larger portion of the signal are subject to compression.

ATK

Attack sets the time of the compressor attack phase, i.e. how quickly the compressor responds to loud peaks.

REL

Release sets the time of the compressor release phase, i.e. how long it takes for the compression to recover in quieter moments.

MUP

Makeup Gain sets the makeup gain of the compressor output, to compensate for the reduced signal levels caused by compression. The Makeup Gain parameter value is displayed in dB.

VOL

Pattern Volume sets the kits overall audio level. This parameter basically has the same function as the **MAIN VOLUME** knob, but is saved together with the kit. Use **LEVEL/DATA** to adjust the settings.

RAT

Compression Ratio. There are eight different compression ratios, 1.50, 2.00, 3.00, 4.00, 6.00, 8.00, 16.00 and 20.00. Higher ratios result in greater compression of the signal.

SCS

Sidechain Source decides what audio source the compressor analyzes when it performs sidechaining. Sidechaining is the process when the compressor uses the output of an audio source to control the overall action of the compressor. For example, if you set **SCS** to TRK1 where you have a kick drum, every time the kick drum plays, the compressor lowers the overall sound of the mix.

COMP MIX sets the sidechain source to be all the tracks that are routed to the compressor.

NOT COMP sets the sidechain source to be all the tracks that are not routed to the compressor.

MAIN sets the sidechain source to be the sound sent to the Main (L/R) outputs.

TRK1-16 sets the sidechain source to be the sound sent from one of the separate audio tracks.

IN LR sets the sidechain source to be the sound coming from IN L/R.

IN L sets the sidechain source to be the sound coming from INPUT L.

IN R sets the sidechain source to be the sound coming from INPUT R.



- The results of the **COMP MIX** and **NOT COMP** settings depends on the selections you make on the **COMPRESSOR ROUTING** page. For more information please see "9.8.1 KIT" on page 37.
- The **IN L** and **IN R** options are only available if you set **DUAL** on the External mixer page to **ON**. The **IN LR** option is only available if you set **DUAL** to **OFF**. For more information, please see "12.9 EXTERNAL MIXER" on page 66.

SCF

Sidechain Filter filters the signal from the sidechain source before the compressor analyzes it. The parameter ranges from a low-pass filter to a high-pass filter. Negative parameter values sets a low-pass filter. Positive parameter values sets a high-pass filter.

When set as a low-pass filter, the compressor reacts mostly to bass frequencies. Use this setting for a characteristic pumping compressor sound. When set as a high-pass filter, the compressor reacts less to bass frequencies. Use this setting to avoid pumping.

DRY/WET MIX

Dry/Wet Mix sets the mix of the uncompressed signal and the compressor output signal. A setting of 0 results in a completely uncompressed signal. A setting of 127 lets only the compressed signal pass through. All values in between mix the uncompressed signal with the compressed signal, which is known as parallel compression.

The Digitakt II compressor

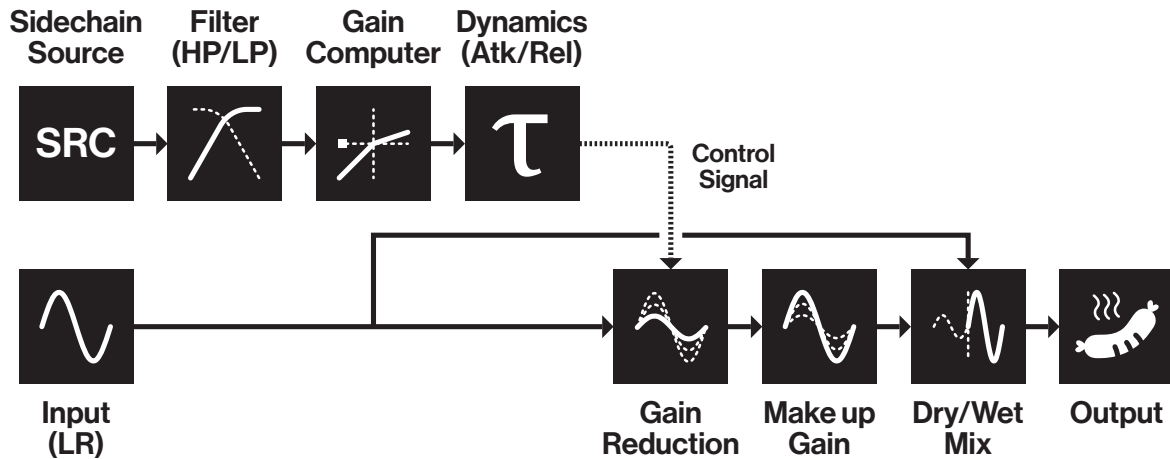

12.6 INTERNAL MIXER PAGE 1

(MIXER PAGE 2)

The INTERNAL MIXER page 1 is where you can access the TRACK LEVEL parameter of track 1-8 (if they are audio tracks).

VOL

Pattern Volume sets the patterns overall audio level. This parameter can be used to balance the volume between different patterns and is saved together with the kit. Use *LEVEL/DATA* to adjust the settings.



12.7 INTERNAL MIXER PAGE 2

(MIXER PAGE 3)

The INTERNAL MIXER page 2 is where you can access the TRACK LEVEL parameter of track 9-16 (if they are non-MIDI tracks).

VOL

Pattern Volume sets the patterns overall audio level. This parameter can be used to balance the volume between different patterns and is saved together with the kit. Use *LEVEL/DATA* to adjust the settings..



12.8 FX MIXER

(MIXER PAGE 4)

On the FX MIXER page you can set the levels of the send effects and master overdrive.

Press [FUNC] + [MOD] four times to access this parameter page.

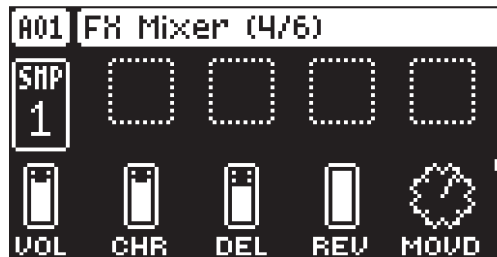

VOL

Pattern Volume sets the patterns overall audio level. This parameter can be used to balance the volume between different patterns and is saved together with the kit. Use *LEVEL/DATA* to adjust the settings.

CHR

Chorus Mix Volume sets the master volume of the chorus.

DEL

Delay Mix Volume Sets the master volume of the delay.

REV

Reverb Mix Volume sets the master volume of the reverb.

MOVD

Master Overdrive sets overall amount of overdrive for the audio tracks in the kit. Use *LEVEL/DATA* to adjust the settings.

12.9 EXTERNAL MIXER

(MIXER PAGE 5)

The EXTERNAL MIXER page contains a number of parameters related to when you use the IN L/R inputs to process incoming audio.



IN LR

In Level sets the level of the audio from the IN L/R audio input.

DUAL

Dual Mono sets if the inputs are processed as a single stereo input or as two separate mono inputs. Setting this parameter to ON changes the rest of the parameters from controlling both inputs to separate controls for channel L and R split over two mixer pages The BAL parameters changes to a PAN parameter. Use *B* to adjust this parameter.

BAL

Balance sets the balance of the audio from the INPUT L and INPUT R inputs in the stereo field.

VOL

Pattern Volume sets the patterns overall audio level. This parameter can be used to balance the volume between different patterns and is saved together with the kit. Use *LEVEL/DATA* to adjust the settings.

CHO

Chorus send sets the amount of sound from the IN L/R audio input that is sent through to the chorus effect. For more information, please see "12.4 CHORUS" on page 63.

DEL

Delay send sets the amount of sound from the **IN L/R** audio input that is sent through to the delay effect. For more information, please see "13.3 DELAY" on page 60

REV

Rev send sets the amount of sound from the **IN L/R** audio input that is sent through to the reverb effect. For more information, please see "13.4 REVERB" on page 62.



If you set **DUAL** to **ON**, the first **EXTERNAL MIXER** page will control the audio from **INPUT L**. You also get an additional **EXTERNAL MIXER** page (6) that control the audio from **INPUT R**. The **DUAL** setting also affects the options you have for the **SRC** parameter in the sample recorder. For more information, please see "13.1.1 SRC" on page 68.



- Setting the **MON** parameter on the **SAMPLING** menu to **DRY** disables the External in mixer functionality. For more information, please see "13.1 SAMPLING MENU" on page 68.
- After you load/reload a project, or after pressing **[STOP] + [STOP]**, you must trig or play an audio track to activate the effects for the External in mixer.

13. SAMPLING

Digitakt II is a very competent and accessible sampler. It can sample audio from external sources via the external inputs, and sample audio internally from the Digitakt II itself. It can also sample over USB when it is connected as a soundcard. The maximum sampling time is 66 seconds and this is always available even if a project's 400 MB of RAM memory is all used up.

13.1 SAMPLING MENU

The SAMPLING menu offers settings that control the different aspects of sampling.

Press [SAMPLING] to access this menu. Use the *DATA ENTRY* knobs to change the parameters.



13.1.1 SRC

Source selects between different incoming audio sources to sample from.

- **MAIN L R** sets the input source to the Digitakt II internal main audio L and R channels.
- **USB L R** sets the input source to USB (left+right channel) and lets you sample audio using a connected class compliant audio host.
- **TRK1-16** sets the input source to one of the Digitakt II's internal tracks.
- **IN L R** sets the input source to INPUT L and R which lets you sample from external sources.



Which sources that are available are affected by the setting of the **DUAL** parameter on the **EXTERNAL MIXER** page. For more information, please see "12.9 EXTERNAL MIXER" on page 66.

13.1.2 RECORD NOW

Press [YES] to start sampling. Press [YES] to stop sampling. This quick way of sampling does not consider the **THRES** and **ARM** parameter settings.

13.1.3 THRES

If you have selected to arm the sampler, the sampling begins when the incoming audio signal exceeds the threshold set by this parameter provided that **R.STRT** is set to **THRES**. Set the threshold high enough so that it is not triggered by background noise, but low enough that you capture all of the signal.

13.1.4 MON

Selects the option to monitor the incoming audio through the Digitakt II's mixer and effect settings on the **EXTERNAL MIXER** page (**POST MIX**) or not (**PRE MIX**). The **MON** parameter is only available if **SRC** is set to **IN L R**.



- Please note that the recorded audio will always be the dry input signal and without the Digitakt II's effects added.
- Setting the **MON** parameter to **PRE MIX** disables the External In mixer functionality. For more information, please see "12.9 EXTERNAL MIXER" on page 66.
- If **MON** is set to **PRE MIX**, make sure that the **IN L R** setting on the **EXTERNAL MIXER** page is turned up or else you will not hear any sound.

13.1.5 R.LEN

Record Length sets the length of the sampling. With a setting of 1-128 steps, the sampling length is decided by the time that it takes the sequencer to advance the set number of steps at the current BPM. With the **MAX** setting, the sampling continues until max sampling time (66 seconds) is reached or until you press [YES] to stop sampling.

13.1.6 R.STRT

Record Start lets you set if the recorder will start sampling when you press **[PLAY]** or when the level of the audio source exceeds the threshold level set by **THRES** and with **ARM** set to **ON**

13.1.7 ARM

When **ARM** is set to on, the recorder will start sampling when the incoming audio exceeds the threshold level. See **THRES** above. You can also press **[SAMPLING] + [YES]** to arm the recorder. Press **[SAMPLING] + [NO]** to cancel.

13.2 SAMPLING AUDIO

1. If you use an external audio source, connect it to the Digitakt II.
2. Press **[SAMPLING]** to access the **SAMPLING** menu and then use **DATA ENTRY** knob **A** to set **SRC** to your preferred audio input source.
3. Keep an eye on the audio input meter and play the audio source and make sure that the volume of the audio source is as strong as possible, but without clipping or distorting. Set **MON** to **YES** to monitor the incoming audio through the Digitakt II (available if you sample from an external source).
4. Again, with an eye on the audio input meter, use **DATA ENTRY** knob **D** to set **THRES** just above the indicated background noise of the audio source (when it is not playing).
5. Use **RLEN** to set the length of the sampling.
6. Set **R.START** to **THRES**.
7. Set **ARM** to **ON** to arm the sampler and then play the sound source. When the audio signal exceeds the set threshold level, sampling will start.
8. Press **[YES]** when you want to stop sampling, or with an **RLEN** setting of 1–128, the sampling stops automatically. The sampling also stops if it reaches the max sampling time (66 seconds). The Digitakt II then automatically normalizes the sample.
9. Use the **DATA ENTRY** knobs **E** and **H** to set the parameters **TRIM START** and **TRIM END** to trim the sample to the desired length. You can use the **DATA ENTRY** knobs **F** to zoom in and out to make it easier to see where to trim the sample. Use **[FUNC] + F** to zoom vertically. Use knob **G** to position the zoom focus area. **[FUNC] + G** moves the trim selection left or right. When zoomed, pressing **[LEFT]** will jump to the **START** trim point, and **[RIGHT]** will jump to the **END** trim point. Press **[FUNC] + [YES]** to preview the sample. **DATA ENTRY** knobs **D** selects the way the sample will be previewed. One shot, Looping, One shot (without having to hold the shortcut all the way), Looping (without having to hold the shortcut all the way). The preview is played back by the voice of the active track. Make sure to select an audio track as the active track. Press **[YES]** to trim the sample and save it. Press **[FUNC] + [NO]** if you want to discard the sample.

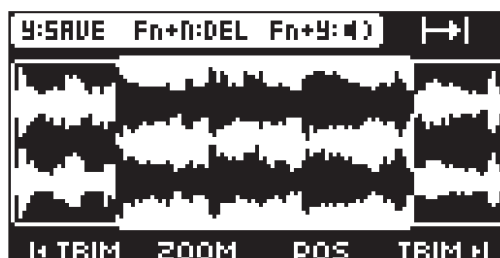

10. Name the sample and press **[YES]** again to confirm the save.
11. Press **[TRACK 1–16]** if you want to select a track to where you want to assign the sample. Press **[NO]** if you don't want to assign the sample to a track.

13.3 ASSIGNING A SAMPLE TO A TRACK FROM THE +DRIVE

You can also assign samples from the +Drive storage in the Digitakt II to the tracks.

1. Press **[FUNC] + [SAMPLING]** to access the **SAMPLES** menu, and then select **+DRIVE** and press **[YES]**.
2. Navigate to the sample you want to assign, and then press **[YES]** to select the sample.
3. Press **[RIGHT]**, to open the **SAMPLE ACTION** menu and then select **LOAD TO PROJECT** and press **[YES]** to copy and load the sample to the project.
4. Press **[YES]** to confirm.
5. Press **[FUNC] + [SAMPLING]** to exit the **SAMPLES** menu
6. Press **[TRACK] + [TRIG 1–16]** to select the track to where you want to assign the sample.

7. Press [SRC] to access the SOURCE menu, and then use *DATA ENTRY* knob *D* to select the sample you want to load to the selected track.
8. Press [YES] to load the sample to the track.

For more information, please see "13.6 SAMPLES MENU" on page 70.

13.4 SAMPLE PLAYBACK

Once the sample is assigned to a track, it can be triggered either by the sequencer or manually by pressing a [TRIG] key. You also have the ability to set the samples play mode and edit what portion of the sample is played.

1. Press [SRC] to access the SOURCE page.
2. Set the **TUNE** of the sample.
3. Set the **PLAY MODE** behavior of the sample.
 - **REVERSE** The sample will be played back in reverse once every time it is triggered.
 - **REVERSE LOOP** The sample will loop continuously in reverse between Loop Position and Length. How long it will loop for is set with the LEN parameter on the TRIG page. The loop time is also constrained by the AMP page envelope parameter settings **HLD** and **DEC**.
 - **FORWARD LOOP** The sample will start from the start position and then loop continuously between Loop Position and Length. How long it will loop for is set with the LEN parameter on the TRIG page. The loop time is also constrained by the AMP page envelope parameters **HLD** and **DEC**.
 - **FORWARD** The sample will be played back once every time it is triggered.
4. Use *DATA ENTRY* knobs *E*, *F*, and *G* to set the **STRT**, **LEN**, and **LOOP** parameters which define what portion of the sample is played. Press [SRC] twice to access SRC page 2, in order to more easily see these settings using the sample waveform.



- **STRT** Start sets the start position for the playback of the sample.
- **LEN** Length sets the length of the playback of the sample. Start + Length effectively defines the end point of the portion of the sample that is played.
- **LOOP** Loop Position sets the position in the sample to where playback will return after reaching the Length Position (defined by **STRT** + **LEN**) if **PLAY MODE** is set to FORWARD LOOP or REVERSE LOOP. The sample then loops between the end of **LEN**, and **LOOP**.

For more information, please see "11.4 SRC PAGE" on page 55.

13.6 SAMPLES MENU

Press [FUNC] + [SAMPLING] to open the SAMPLES menu.

Use the [UP]/[DOWN] keys to select if you want to view the +Drive or the RAM storage. Press [YES] to open the selected storage space.

Here you can manage your samples. Initially, here are two directories FACTORY and INCOMING. A wide array of factory samples are available in the write protected FACTORY directory. The INCOMING directory is the default destination for samples sent to the Digitakt II +Drive storage via a SDS transfer software. A third directory, RECORDED will appear once you have done the first sampling on the device and will contain the samples you create when you sample with the Digitakt II.



Use the [UP]/[DOWN] keys to highlight a directory, and then press [YES] to open it. To exit a directory and back one step up in the directory hierarchy, press [NO]. When browsing a directory in the +Drive, a sample assigned to one of the 1016 sample slots of the active project will have its slot number shown as seen below.

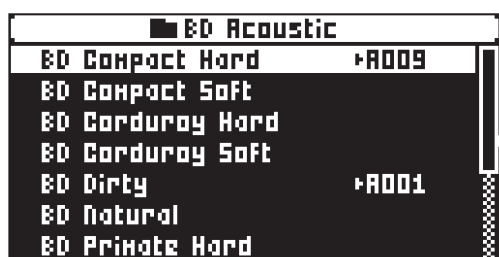

13.6.1 LOADING A SAMPLE

You can load one or several samples to the RAM memory of the active project.

1. Press [FUNC] + [SAMPLING] to open the SAMPLES menu, and then use the [UP]/[DOWN] keys to select +DRIVE. Press [YES] to open the +Drive storage.
2. Open the FACTORY directory, and navigate to the samples you want to load.
3. Highlight the samples, and then press [YES] to select them. Press [YES] on a selected sample to deselect it. Any sample can be previewed, played back by the voice of the active track (make sure to select an audio track). Highlight the sample and then press [FUNC] + [YES]. Approximately, ten seconds of the sample can be previewed.
4. Press [RIGHT] to open the SAMPLE ACTION menu.



5. Select LOAD TO PROJECT and press [YES].

The samples you selected (ticked) will now appear in the first available empty slots out of the 1016 sample slots of the active project. To view the samples currently in the RAM storage of the active project, press [FUNC] + [SAMPLING] to open the SAMPLES menu, and then use [UP]/[DOWN] to select the PROJECT RAM. Press [YES] to open the RAM storage.

If you instead what to load the samples to a specific RAM bank, press [FUNC] + [YES] and then use [LEFT]/[RIGHT] or LEVEL/DATA or [TRIG 9-16] to select RAM bank.



On this screen, the 1016 samples may be unloaded individually or collectively to empty the slots.

13.6.2 UNLOADING A SAMPLE

You can unload one or several samples from the RAM memory of the active project.

1. Press **[FUNC]** + **[SAMPLING]** to open the SAMPLES menu, and then use the **[UP]/[DOWN]** keys to select the PROJECT RAM. Press **[YES]** to open the projects RAM storage.
1. Scroll the list using **[UP]/[DOWN]** or the *LEVEL/DATA* knob.
2. Highlight the samples, and then press **[YES]** to select the samples, or bring up the SAMPLE ACTION menu by pressing **[RIGHT]** and choose SELECT ALL.
3. Press **[YES]** and then select UNLOAD, and then press **[YES]** again to empty the slots of the selected samples.



13.6.3 REPLACING A SAMPLE

You can replace a sample in the RAM memory of the active project.

1. Highlight the slot containing the sample you wish to replace, and then (without selecting any samples) press **[RIGHT]** to open the SAMPLE ACTION menu, and select REPLACE, and then press **[YES]** again.
2. Browse the directories of the +Drive, locate the desired sample and press **[YES]** to place it in the previously highlighted sample slot.

If you wish to go back to browsing the +Drive storage directories, press **[NO]** to go back to the SAMPLES menu, and then use the **[UP]/[DOWN]** keys to select +DRIVE. Press **[YES]** to open the +Drive storage.

13.6.4 RENAMING A SAMPLE

You can also rename a sample.

1. Navigate to the directory that contains samples you want to rename.
2. Highlight the sample you want to rename, and then press **[YES]** to select it.
3. Press **[RIGHT]** to open sample action menu, and then Select RENAME and press **[YES]**.
4. Use the NAMING screen to rename the sample and then press **[YES]**.

13.6.5 MOVING A SAMPLE

You can move one or several samples from one directory to another.

1. Navigate to the directory that contains samples you want to move.
2. Highlight the samples you want to move, and then press **[YES]** to select them.
3. Press **[RIGHT]** to open the SAMPLE ACTION menu.

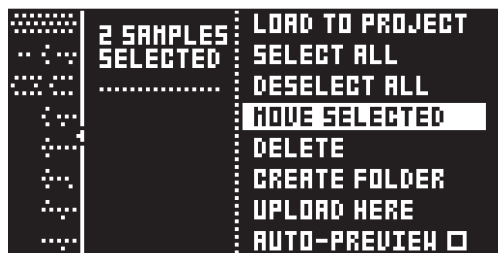

4. Select MOVE SELECTED and press **[YES]**.
5. Navigate to the directory to where you want to move the samples.

6. Press **[RIGHT]** to open the SAMPLE ACTION menu and then highlight MOVE HERE.
7. Press **[YES]** to move the samples.

13.6.6 REMOVING UNUSED SAMPLES FROM RAM

You can use this feature to remove all samples that are not used in any pattern in the project from the RAM memory. The samples are not removed from the +Drive.

1. Press **[FUNC]** + **[SAMPLING]** to open the SAMPLES menu, and then use the **[UP]/[DOWN]** keys to select PROJECT RAM. Press **[YES]** to open the RAM memory.
2. Press **[RIGHT]** and the SAMPLE ACTION menu will appear. Select SELECT UNUSED, and then press **[YES]**.
3. Select UNLOAD. A warning popup will appear asking "UNLOAD X SAMPLES? CONFIRM? Y/N". Press **[YES]** to remove all unused samples.

13.6.7 TRANSFERRING SAMPLES FROM A COMPUTER TO DIGITAKT II

1. Connect Digitakt II to the computer via USB.
2. Open the Elektron Transfer software (Available on the Elektron website) on your computer.
3. On the Transfer CONNECTIONS page, set the MIDI IN and OUT ports to your Digitakt II.
4. In Transfer, click the EXPLORE tab to open the EXPLORE page.
5. On the top right side, in the drop-down menu, select "Samples".
6. On the top left side in the drop-down menu, make sure "My Computer" is selected.
7. Under "My Computer" navigate to the files or folders you want to transfer.
8. Drag and drop the files or folders to your preferred location on your device. Transfer automatically converts all audio files to 16 bit, 48 kHz, mono audio files, the Digitakt II native audio format.

To use the samples, they need to be loaded to the active project. For more information, please see "13.6.1 LOADING A SAMPLE" on page 71.

13.6.8 CREATING A NEW DESTINATION DIRECTORY

The Digitakt II still supports receiving of samples via MIDI Sample Dump Standard (SDS) and Extended SDS. You need to enable SDS Handshake in order to secure the transmission over fast interfaces like USB MIDI. You also have to enable the transmission of the Extended SDS header if you want the sample name to be sent to the Digitakt II.

This procedure is only for when you use a SDS transfer software tool. If you use Elektron Transfer you can create a new destination directory in the Digitakt II directly from Transfer.

Press **[FUNC]** + **[SAMPLING]** to open the SAMPLES menu, and then use the **[UP]/[DOWN]** keys to select the +Drive. Press **[YES]** to open the +Drive storage. Press **[RIGHT]** and select CREATE DIR to create a new directory by pressing **[YES]**. A naming screen will appear. Give your new destination directory an appropriate name. Press **[YES]** to open the new directory. In the initially empty directory, press **[RIGHT]** to open the SAMPLE ACTION menu. Highlight UPLOAD HERE and press **[YES]**.

13.6.9 TRANSFERRING SAMPLES FROM DIGITAKT II TO A COMPUTER

1. Connect Digitakt II to the computer via USB.
2. Open the Elektron Transfer software (Available on the Elektron website) on your computer.
3. On the Transfer CONNECTIONS page, set the MIDI IN and MIDI OUT ports to your Digitakt II.
4. In Transfer, click EXPLORE to open the EXPLORE page.
5. On the EXPLORE page on the right side under DIGITAKT II, navigate to the samples you want to transfer
6. Drag and drop the samples to your preferred folder under MY COMPUTER.



- Make sure you have the latest version of the Elektron Transfer software installed on your computer. You can download the free Transfer software and the Transfer User Manual from the Support section of the Elektron website.
- If MIDI+USB is selected in the INPUT FROM and/or OUTPUT TO settings on the MIDI PORT CONFIG menu, MIDI data transfers will limit the USB speed. When sending or receiving large chunks of data, make sure you use the USB setting.
- Sequencer playback stops when you transfer files to the Digitakt II.

14. SETTINGS MENU

The SETTINGS menu offers settings that affect Digitakt II and can also be used to manage Projects.

Press [SETTINGS] to access the SETTINGS menu. Scroll the list by using [UP]/[DOWN] or the *LEVEL/DATA* knob. Open a highlighted menu by pressing [YES].



14.1 PROJECT

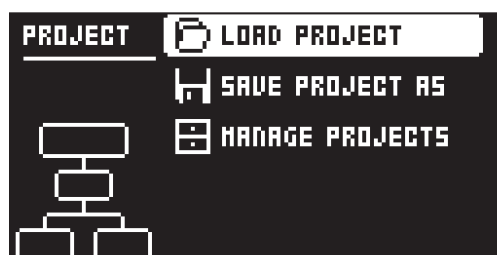

14.1.1 LOAD PROJECT

Load Project opens a project selection screen where you can choose a project to load. If you wish to create a new project, select CREATE NEW at the very bottom of the list. The new project will be a blank slate.



If you load a new project it will replace the active project. Be sure to save your active project before you load another project.

14.1.2 SAVE PROJECT AS

Save Project opens a project selection screen where you choose a slot to save the active project to. You can also press [FUNC] + [SETTINGS] to save and overwrite the current project.

14.1.3 MANAGE PROJECTS

Manage Projects launches the PROJECT MANAGER menu. Selecting a project in this menu and pressing the [RIGHT] arrow key will bring up a list of commands.

- **CLEAR** Resets the project slot to a clean state.
- **DELETE** Removes the project from the slot.
- **RENAME** Opens a NAMING screen where you can rename the project file.
- **LOAD FROM** Loads the selected project. This will replace the active project!
- **SAVE TO** Saves the active project to the selected slot.
- **TOGGLE** Toggles write protection on or off. Write protected projects cannot be overwritten, renamed or erased. A lock symbols in front of the project name shows that the project is write protected.
- **INIT NEW** Initializes an empty file slot with a clean project. This option is only available for empty project slots.
- **PURGE ALL** Purges (removes) all presets from the pool and all samples that are not used in any pattern in the project from the RAM memory. The presets and samples are not removed from the +Drive library. This option is only available when you select the currently loaded project.

14.2 SONG

In this menu, you can perform tasks related to songs. For more information, please see "10.9 SONG MODE" on page 50.



14.2.1 RENAME

Opens the NAMING screen where you can rename the active song.

14.2.2 CLEAR

Clears the active song.

14.2.3 LOAD

Opens a screen where you can select and load songs

14.2.4 SAVE TO PROJ

Saves the active song to the project.

14.3 PATTERN MENU

Use the PATTERN menu to perform pattern management. Use the [UP] and [DOWN] arrow keys to move between the options. Press [YES] to confirm your selection. Press [NO] to exit the menu.



14.3.1 RENAME

Opens the NAMING screen where you can rename the active pattern.

14.3.2 CLEAR

- **WHOLE PATTERN** Clears the active pattern's sequencer data and kit. A prompt appears when you select this option. Press [YES] to clear, or [NO] to cancel the operation. Note that no pattern information will be permanently lost until the pattern is saved to the same pattern slot that it was loaded from.
- **KIT DATA** Clears the active pattern's kit. All sequencer data will remain unchanged. A prompt appears when you select this option. Press [YES] to clear, or [NO] to cancel the operation. Note that no kit information will be permanently lost until the pattern is saved to the same pattern slot that it was loaded from.
- **SEQUENCE DATA** Clears the active pattern's sequence data. All presets will remain unchanged. A prompt appears when you select this option. Press [YES] to clear, or [NO] to cancel the operation. Note that no sequencer information are permanently lost until the pattern is saved to the same pattern slot it was loaded from.

14.3.3 SAVE TO PROJ

You must have saved the project at least once before you can save pattern information.

- **WHOLE PATTERN** Saves the active pattern's sequence data and kit to the +Drive. A prompt appears when you select this option. Press [YES] to save, or [NO] to cancel the operation.
- **KIT DATA** Saves the active pattern's kit to the +Drive. A prompt appears when you select this option. Press [YES] to save, or [NO] to cancel the operation.

- **SEQUENCE DATA** Saves the active pattern's sequence data to the +Drive. A prompt appears when you select this option. Press **[YES]** to save, or **[NO]** to cancel the operation.

14.3.4 RELOAD FROM PROJ

You must have saved the pattern at least once before you can reload pattern information.

- **WHOLE PATTERN** Reloads the active pattern's sequence data and kit from the +Drive. A prompt will appear when you select this option. Press **[YES]** to reload, or **[NO]** to cancel the operation.
- **KIT DATA** Reloads the active pattern's kit from the +Drive. A prompt appears when you select this option. Press **[YES]** to reload, or **[NO]** to cancel the operation.
- **SEQUENCE DATA** Reloads the active pattern's all sequence data from the +Drive. A prompt appears when you select this option. Press **[YES]** to reload, or **[NO]** to cancel the operation.

14.4 MIDI CONFIG

In this menu, various sub-menus dealing with the MIDI functionality of Digitakt II are found.



14.4.1 SYNC

Controls how Digitakt II receives and sends MIDI clock and transport commands. Change settings by using the **[LEFT]/[RIGHT]** arrow keys or the **[YES]** key.



CLOCK RECEIVE sets whether or not Digitakt II responds to MIDI clock sent from external devices.

CLOCK SEND sets whether or not Digitakt II transmits MIDI clock.

TRANSPORT RECEIVE sets whether or not Digitakt II responds to MIDI transport messages sent from external devices.

TRANSPORT SEND sets whether or not Digitakt II transmits MIDI transport messages.

PRG CH RECEIVE will, when active, make Digitakt II respond to incoming program change messages, which is useful when wanting to select patterns externally. The MIDI channel that will listen to incoming program change messages is set in the MIDI CHANNELS menu. For more information, please see "14.4.3 CHANNELS" on page 78.

PRG CH SEND will, when active, send program change messages when patterns are changed. The MIDI channel that will send program change messages is set in the MIDI CHANNELS menu. For more information, please see "14.4.3 CHANNELS" on page 78.

14.4.2 PORT CONFIG

Here you find the MIDI port related settings. Change settings by using the **[LEFT]/[RIGHT]** arrow keys.

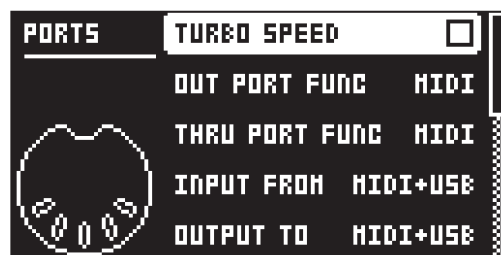

TURBO SPEED press [YES] to start the turbo speed negotiation. Speed is chosen automatically. Please note that you must use a MIDI interface that supports the Turbo-MIDI protocol.

OUT PORT FUNCTIONALITY selects what type of signal the MIDI OUT port will send.

- **MIDI** makes it possible for the port to send out MIDI data.
- **DIN 24** will make the port send DIN 24 sync pulses. No MIDI data is transferred over the port when this option is selected.
- **DIN 48** will make the port send DIN 48 sync pulses. No MIDI data is transferred over the port when this option is selected.

THRU PORT FUNCTIONALITY selects what type of signal the MIDI THRU port will send. The settings are the same as for OUT PORT FUNCTIONALITY.

INPUT FROM selects the source Digitakt II will receive MIDI data from.

- **DISABLED** will make Digitakt II disregard any incoming MIDI data.
- **MIDI** will make Digitakt II listen only to MIDI data sent to the MIDI IN port.
- **USB** will make Digitakt II listen only to MIDI data sent to the USB port.
- **MIDI+USB** will make Digitakt II listen to MIDI data sent to both the MIDI IN and USB ports.

OUTPUT TO selects the destination to which Digitakt II will send MIDI data.

- **DISABLED** will stop Digitakt II from sending out any MIDI data.
- **MIDI** will make Digitakt II send MIDI data to the MIDI OUT port only.
- **USB** will make Digitakt II send MIDI data to the USB port only.
- **MIDI+USB** will make Digitakt II send MIDI data to both the MIDI OUT and USB ports.



If **MIDI+USB** is selected in the **OUTPUT TO** settings, MIDI data will limit the USB speed. When sending large chunks of data, make sure you only use the USB setting.

OUTPUT CH selects whether the **DATA ENTRY** knobs will send data on the auto channel or the track channel.

PARAM OUTPUT selects what type of MIDI messages the **DATA ENTRY** knobs will send. For information about which CC/NRPN parameters that will be sent, please see "APPENDIX B: MIDI" on page 104.

- **CC** will make the knobs send out CC MIDI messages.
- **NRPN** will make the knobs send out NRPN MIDI messages.

ENCODER DEST controls whether the **DATA ENTRY** and **LEVEL/DATA** knobs sends MIDI data or not. When set to INT, the knobs only affects the Digitakt II and no MIDI data is sent. When set to INT + EXT, the knobs affects the Digitakt II and also sends MIDI data to external devices.

TRIG KEY DEST controls whether the [TRIG] keys sends MIDI data or not. When set to INT, the [TRIG] keys only affects the Digitakt II and no MIDI data is sent. When set to INT + EXT, the [TRIG] keys affects the Digitakt II, and also sends MIDI data to external devices. When set to EXT, the [TRIG] keys do not affect the Digitakt II but MIDI data is sent externally.

MUTE DEST controls whether activating/deactivating mutes will send MIDI data or not. When set to INT, mute only affects the Digitakt II and no MIDI data is sent. When set to INT + EXT, mute affects the Digitakt II and also send MIDI data to external devices. When set to EXT, mute sends MIDI data externally, but do not affect the Digitakt II.

RECEIVE NOTES will, when active, make it possible to play Digitakt II using an external MIDI keyboard.

RECEIVE CC/NRPN will, when active make it possible to control Digitakt II's parameters from an external MIDI device sending CC/NRPN data.

14.4.3 CHANNELS

This menu handles the MIDI channel configuration.



TRACK 1-16 selects the dedicated MIDI channel that is used to receive or send (by turning the knobs) parameter data to or from a specific audio track. If configured as OFF, parameter data are neither received nor sent via MIDI.



The sequencer data is always sent on the MIDI channel specified by the CHAN parameter on the SRC PARAMETER page.

FX CONTROL CH selects the dedicated MIDI channel that is associated with the parameters on the DELAY, REVERB, CHORUS, and COMPRESSOR parameter pages together with the master overdrive, both for input and output. If configured as OFF, parameter data are neither sent nor received via MIDI.

AUTO CHANNEL selects the MIDI channel that will give access to the currently active track. If an external MIDI keyboard connected to Digitakt II sends MIDI data on this channel, the keyboard will control the active track. This is useful when for example quickly changing between the active audio tracks to play different presets. The Digitakt II also uses the AUTO channel to record to the MIDI tracks from external MIDI controllers.

PROGRAM CHG IN CH selects the MIDI channel that will listen for incoming program change messages. An AUTO setting will use the AUTO channel. Enable Digitakt II to respond to program change messages in the MIDI SYNC menu. For more information, please see "14.4.1 SYNC" on page 76.

PROGRAM CHG OUT CH selects the MIDI channel that will send program change messages when changing patterns. An AUTO setting will use the AUTO channel. Enable Digitakt II to send program change messages in the MIDI SYNC. For more information, please see "14.4.1 SYNC" on page 76.

14.5 SYSEX DUMP

In the SYSEX DUMP menu, project, pattern, and preset data can be sent and received via the MIDI OUT port or the USB port of the Digitakt II. Select a menu option using [UP]/[DOWN] or the **TRACK LEVEL** knob. Press [YES] to open the highlighted menu selection.



When receiving or sending SysEx data, the MIDI ports or the USB port of the Digitakt II should be connected to the external sending/receiving device.



Please note that Sysex dump only sends and receives project, pattern and preset data. It does NOT send or receive the presets samples.

14.5.1 SYSEX SEND

Here projects, patterns, and presets can be sent to an external device.



The column to the left selects what will be backed up. Select the column using the **[LEFT]** arrow key. Use the **[UP]/[DOWN]** keys or the **LEVEL/DATA** knob to navigate in the column. The SysEx data send alternatives located in the column to the right will change depending on the selection made in the left column. Press the **[RIGHT]** arrow key to access this column. Use the **[UP]/[DOWN]** keys or the **LEVEL/DATA** knob to select what will be sent. Press **[YES]** to initiate the SysEx send procedure.

PROJECT will send the active project (settings, patterns, presets in the pool).

PATTERN will send the selected pattern.



- Backing up your data regularly is important!
- Before initiating a SysEx send, first, make sure the receiving device is listening for data to be sent.

14.5.2 SYSEX RECEIVE

Here projects, patterns, and presets can be received from an external device. Digitakt II is continuously listening for SysEx data so you can at any time send backed up projects or patterns to the device.



The column to the left selects what will be received. Select the column using the **[LEFT]** arrow key. Use the **[UP]/[DOWN]** keys or the **LEVEL/DATA** knob to navigate in the column. The SysEx data receive alternatives located in the column to the right will change depending on the selection made in the left column. Press the **[RIGHT]** arrow key to access this column. Use the **[UP]/[DOWN]** keys or the **LEVEL/DATA** knob to select what will be received. Press **[YES]** to initiate the SysEx receive procedure. The Digitakt II starts listening to incoming data. Press **[NO]** to stop listening.

PATTERN will store a received pattern to the selected pattern slot.

PRESETS will store a received preset to the selected slot of the +Drive library. The option ANY-WHERE will place the preset in the first free slot available. To the right of the bank indication, the amount of free slots can be seen.

14.6 AUDIO ROUTING

Here you find number of audio routing options that affects the Digitakt II on a global level.



14.6.1 TO MAIN

Use this option to customize which of the 16 tracks, 3 effects (Delay, Reverb, Chorus), and inputs that will send audio to the MAIN OUT outputs. Use **[UP]/[DOWN]** to switch between the setup pages. Use

the [TRIG] keys to activate/deactivate the tracks, effects, and inputs that can send to main. Green keys signal send to main. Unlit keys signal do not send to main.

14.6.2 TO FX

Use this option to customize which of the 16 tracks, 2 effects (Delay, Chorus), and inputs that will send audio to the effects. Use [UP]/[DOWN] to switch between the setup pages. Use the [TRIG] keys to activate/deactivate the tracks, effects, and inputs that can send to FX. Green keys signal send to FX. Unlit keys signal do not send to main.

14.6.3 USB IN

Sets where the incoming audio from the class compliant device is routed to in the Digitakt II's signal path. This parameter is only available when **USB CONFIG** is set to USB AUDIO/MIDI. For more information, please see "14.8.1 USB CONFIG" on page 81.

- MAIN** the incoming audio is routed to the Digitakt II's main outputs.
- OFF** No sound is routed from USB to the Digitakt II.

14.6.4 USB OUT

Sets from where in the Digitakt II's signal path, the outgoing audio is routed to the class compliant device. This parameter is only available when **USB CONFIG** is set to USB AUDIO/MIDI. For more information, please see "14.8.1 USB CONFIG" on page 81.

- MAIN** the outgoing audio is routed from the Digitakt II's Main out at the end of the signal path.
- L:T1-16/R:T1-16** the outgoing audio is routed from the selected track(s) Press a [TRIG] key twice to select a single track as a stereo source. The selected track's [TRIG] key lights up white.
- Press first one [TRIG] key and then another to select two separate tracks as sources. The selected tracks' [TRIG] keys lights up blue for left channel and red for right channel. The audio from each track is then summed to mono, routed out and sent separately on left and right channel.
- EXT** the outgoing audio is routed straight from the Digitakt II's audio inputs IN L/R to the class compliant device.
- OFF** no audio is sent to the class compliant device.

14.6.5 INT TO MAIN

Sets if Digitakt II sends internal audio to the MAIN OUT and HEADPHONES OUT or not when used with Overbridge or as a class compliant audio device.

- OFF** No sound is sent to main out.
- ON** preset is always sent to main out.

14.6.6 USB TO MAIN [dB]

Sets the amount of amplification of the sound that is streamed over USB to the Digitakt II main out when used with a class compliant audio device. (0 dB-+18 dB)

14.6.7 PRE/POST FADER

Sets if audio over USB should be pre or post the track level setting.



Audio from the **TRACK OUTPUTS** is always without any effects.

14.7 PERSONALIZE

Here you can customize a number of settings to fit you personal preferences.



14.7.1 LED INTENSITY

Sets the brightness of the key LEDs and screen. Use the [LEFT]/[RIGHT] keys to change the setting (LOW, MID, MAX).

14.7.2 LED BACKLIGHT

Switches the key LEDs backlight on/off.



Press and hold [SETTINGS] for a second and then press [TRIG 1–3] to set the intensity of the key LEDs and screen. Press and hold [SETTINGS] for a second and then press [TRIG 9] to toggle the key LEDs backlight on/off.

14.7.3 REMEMBER SUBPAGE

Will, when selected, remember which PARAMETER page's subpage you last used and access this page again the next time you press the same [PARAMETER] key. Use the [YES] key to toggle this setting. (ON, OFF).

14.7.4 U/D KEY MODE

Sets the functionality of the [UP]/[DOWN] keys. When set to KB OCT and you are in KEYBOARD mode, the keys shift keyboard octave up/down when you are in KEYBOARD mode. When you are not in KEYBOARD mode, then keys navigates between parameter group pages. When set to NAV, the keys only navigate between parameter pages.

14.7.5 PAGE AUTOCOPY

Will, when set to on, automatically copy already placed trigs when extending the length of a pattern. If a pattern consists of for example two pages and the pattern length is increased to four pages, the two additional pattern pages are then copies of the first two pattern pages. For more information, please see "10.7 PAGE SETUP MENU" on page 45.

14.8 SYSTEM

The System menu contains a number of system related settings for the Digitakt II.



14.8.1 USB CONFIG

Here you find settings related to USB audio and MIDI. Selecting one mode disables the other two modes.



USB MIDI select this option if you wish to send and receive MIDI over USB.

USB AUDIO/MIDI sets the Digitakt II to send and receive audio and MIDI over USB. Select this option if you want to use the Digitakt II together with a class compliant USB audio host.

14.8.2 OS UPGRADE

Use this menu option when you want to upgrade the Digitakt II OS. To send the OS file, use our free Elektron Transfer software. Elektron Transfer can be downloaded from the Elektron website.

The device sending the OS file must be connected to the USB port of Digitakt II.

Please note that the Digitakt II will not appear as an icon on your computer desktop.

1. Download the Digitakt II OS file from the Elektron website.
2. Connect the Elektron device to the computer via USB.
3. Open the Transfer application on your computer.
4. On the Transfer CONNECTIONS page, set the MIDI IN and MIDI OUT ports to your Elektron device.
5. On the Transfer DROP page, drag and drop the OS file. The OS file is then automatically transferred to the Elektron device and the OS update initiates. A progress bar is visible on device screen when receiving the OS.
6. On your device. Press [YES] to confirm the OS update.

When the update is done, the Digitakt II will reboot.

14.8.3 FORMAT +DRIVE

You have the possibility to erase all content of the +Drive. Once you have made your choices using the [LEFT]/[RIGHT] keys and confirmed by pressing [YES], a prompt will appear asking if you want to execute the formatting procedure. Press [YES] to proceed with the formatting.



PROJ+PST+KIT Erases all projects, presets, and kits.

SAMPLES Erases all samples.



The factory samples can not be erased and they do not take up any of the 20 GB user space on the +Drive.

14.8.4 STORAGE

Here you get an overview of what is stored in the RAM and the +Drive and how much memory that is available. Other than the number of Projects, presets, kits, and samples, and you also see the amount of sample time used and remaining. On the right, you see the memory usage of the RAM and the +Drive.



15. STARTUP MENU

To access this menu, hold down the **[FUNC]** key while powering up the Digitakt II. From here you can perform a variety of tasks. To choose the different alternatives, press the corresponding **[TRIG]** key.

15.1 TEST MODE

To enter this mode, press the **[TRIG 1]** key.



For testing purposes, a short sound is heard through all outputs of the unit.

If you have any trouble with your Digitakt II and suspect it may be due to a hardware problem, perform this self-test. The **[UP]** and **[DOWN]** keys can be used to scroll through the test log. A fully functional device should not report any errors. If it does report an error, please contact Elektron support or the retailer that you bought your Digitakt II from.

15.2 EMPTY RESET

To perform this operation, press the **[TRIG 2]** key. All patterns and presets will be erased. The data on the +Drive remains intact.

15.3 FACTORY RESET

When performing a factory reset on the Digitakt II, it will overwrite and re-initialize the active RAM project (including all pattern and global data). The +Drive project slot 1 will be overwritten and re-initialized with factory preset patterns, presets and settings. preset bank A will be overwritten with the factory presets.

If you wish to keep the active project, remember to save it to a +Drive project slot higher than 1 before you perform a factory reset. To perform a factory reset, press the **[TRIG 3]** key.

15.4 OS UPGRADE

Use this menu option if you for some reason cant upgrade the Digitakt II OS using the standard procedure in the SYSTEM menu. To send the OS file, use our free Elektron Transfer software. The Elektron Transfer can be downloaded from the Elektron website.

1. Download the Digitakt II OS file from the Elektron website.
2. Connect the Digitakt II's MIDI IN port to the MIDI OUT port of the computer's MIDI interface.
3. Hold down the **[FUNC]** key while powering on Digitakt II. This takes you to the STARTUP menu.
4. Press the **[TRIG 4]** key to enter OS UPGRADE mode.
5. Open the Transfer application on your computer. On the Transfer CONNECTION page, click "go to the SYSEX TRANSFER page".
6. On the SYSEX TRANSFER page, click "OS Upgrade via device startup menu", and then follow the on-screen instructions.

When the update is done, the Digitakt II will reboot.



USB MIDI transfer is not possible when upgrading the OS from the STARTUP menu.

15.5 EXIT

Press the **[TRIG 5]** key to exit the STARTUP menu.

16. SETUP EXAMPLES

The Digitakt II likes to play with other machines. Whether it uses its ability to sync and play with legacy machines, samples from your smart phone or controls other synthesizers: Digitakt II gets along with other gear.

16.1 DIGITAKT II WITH A MONOPHONIC BASS MACHINE

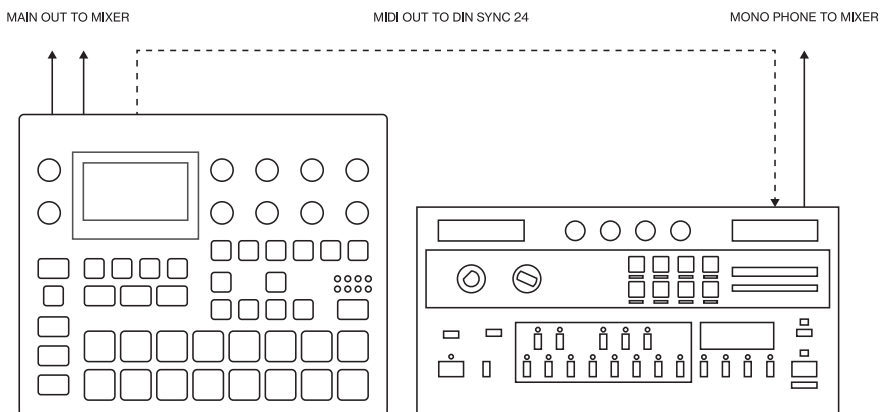

The DIN sync capabilities of the Digitakt II allows you to use gear from yesteryear.

In this example, a legacy monophonic bass machine is used alongside the Digitakt II. The Digitakt II can stop, start and control the tempo of the bass machine.

1. Prepare a bassline pattern on the bass machine.
2. Connect the output of the bass machine to the mixer using a Mono jack 6.3 mm male cable.
3. Connect the Digitakt II audio outputs to the mixer using 2 x Mono or Stereo jack 6.3 mm male cables.
4. Use a DIN connector cable to connect the MIDI OUT of the Digitakt II to the SYNC IN of the bass machine.
5. On the Digitakt II, press **[SETTINGS]**, and then navigate to MIDI CONFIG > PORT CONFIG and set **OUT PORT CONFIG** to DIN24.

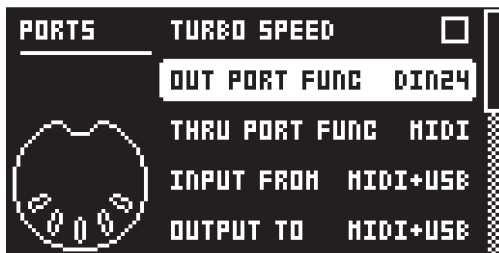

6. Press **[PLAY]** on the Digitakt II.

16.2 DIGITAKT II WITH A SMART PHONE

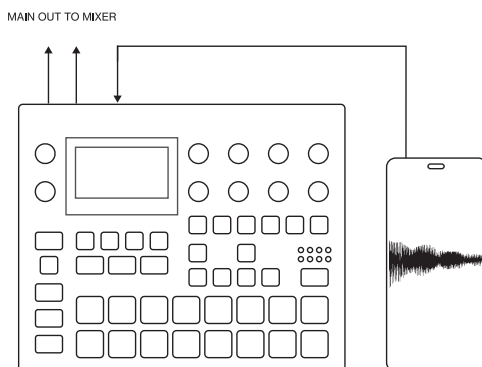

Digitakt II can make use of its class compliant audio and MIDI functionality together with your computer, smart phone or tablet. You can let Digitakt II sample audio from the phone or maybe use it the other way around and record audio from the Digitakt II on your phone. You can use your phone as an effect processor for the Digitakt II, and among many other things. In this example, we use Digitakt II to sample audio from the phone.

1. Use a cable or adapter to connect your phone's data connector jack (Lightning, USB-C or other) to the Digitakt II's USB-B jack.
2. Navigate to **SETTINGS > SYSTEM > USB CONFIG** and select **USB AUDIO/MIDI**.
3. Press **[SAMPLING]** to access the **SAMPLING** menu and then use **DATA ENTRY** knob **A** to set **SOURCE** to **USB L R**.



4. You are now ready to start sampling audio from your smart phone. For more information about the sampling process, please see "13. SAMPLING" on page 68.

16.3 CONTROLLING A SYNTHESIZER USING THE MIDI TRACKS

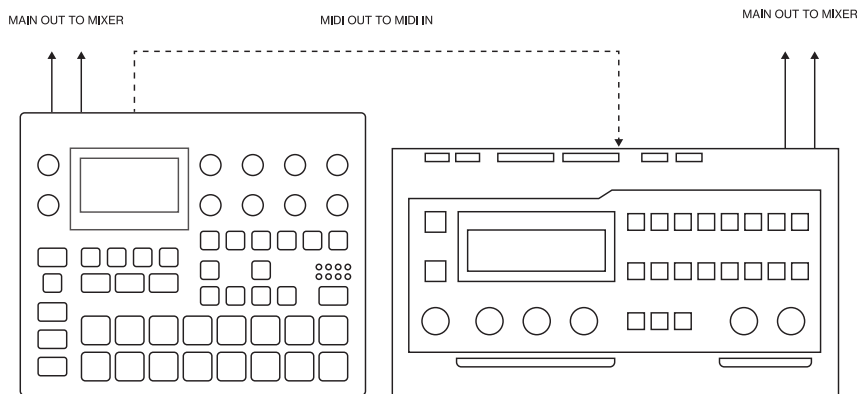

Digitakt II has extensive capabilities to use its sequencer's MIDI tracks to control other MIDI-equipped synthesizers.

1. Use a standard MIDI cable to connect the Digitakt II MIDI OUT jack with the synthesizer's MIDI IN jack.
2. On the Digitakt II, press **[SETTINGS]**, and then navigate to **MIDI CONFIG > PORT CONFIG** and set **OUT PORT FUNC** to **MIDI**.
3. In the same menu set **OUTPUT** to **MIDI**.

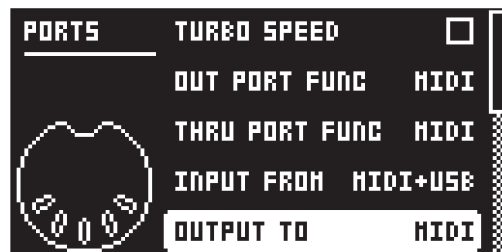

4. On the main screen, press **[TRK] + [TRIG 1-16]** to select a track that uses a MIDI SRC machine.
5. Press **[SRC]** and use the **CHAN** parameter to select a MIDI channel that the track will output its data to.
6. Make sure to set your synthesizer to receive MIDI input in a way that corresponds to the settings you made in the Digitakt II.

You are now ready to use the Digitakt II sequencer to control your synthesizer. For more information about using the Digitakt II sequencer, please see "10. THE SEQUENCER" on page 40.

17. KEY COMBINATIONS

Use the key combinations below to quickly perform certain tasks.

COPY/PASTE/CLEAR

TRACK SEQUENCE (ALL TRIGS ON THE TRACK)

When in GRID RECORDING mode.

[TRK] + [RECORD] to copy the active track's sequence.

[TRK] + [STOP] to paste the copied track's sequence to the active track.

[TRK] + [PLAY] to clear the active track's sequence.

TRIG

When in GRID RECORDING mode

[TRIG] + [RECORD] to copy the trig with it's parameter locks.

[TRIG] + [STOP] to paste the copied trig.

[TRIG] + [PLAY] to clear the trig.

PATTERN

[FUNC] + [RECORD] to copy the active pattern.

[FUNC] + [STOP] to paste the copied pattern to the active pattern.

[FUNC] + [PLAY] to clear the active pattern.

PRESET

When in regular trig mode.

[TRK] + [RECORD] to copy the selected track's preset.

[TRK] + [STOP] to paste the copied preset to the selected track.

[TRK] + [PLAY] to clear the selected track's preset.

SEQUENCER PAGE

When in GRID RECORDING mode

[PAGE] + [RECORD] to copy the active page.

[PAGE] + [STOP] to paste the copied page to the active page.

[PAGE] + [PLAY] to clear the active page.

TRACK/PATTERN/BANK SELECT

[TRK] + [TRIG 1-16] keys to select a track.

[PTN] and [LEFT]/[RIGHT] and [TRIG 1-16] keys to select a bank/pattern.

NAMING

[FUNC] + [ARROW] (on the NAMING screen) to choose a letter.

[FUNC] + [NO] (on the NAMING screen) to erase a letter.

[FUNC] + [YES] (on the NAMING screen) to add a blank space.

SAVING AND RELOADING

PATTERN

[FUNC] + [NO] to reload the active pattern.

[FUNC] + [YES] to temporarily save the active pattern.

PRESET

When in GRID RECORDING mode.

[TRIG] + [PRESET/KIT] save the sound of a trig as a preset, taking all parameter locks in consideration.

[TRIG] + [YES] previews the trig.

[FUNC] + [SETTINGS] saves the active project.
 [FUNC] + [YES] temporary saves the active pattern.
 [FUNC] + [NO] temporary reloads the active pattern.

[PARAMETER] key + [NO] reloads all parameters on that parameter page from its last saved state
 [PARAMETER] key + [YES] randomizes parameters on that parameter page
 [TRK] + [TRIG1-16] + [NO] reloads the preset from its last saved state

NAVIGATING

[FUNC] + [RIGHT] (In the SAMPLES menu) opens a directory.
 [FUNC] + [LEFT] (In the SAMPLES menu) exits a directory and backs one step up in the directory hierarchy.

MENU ACCESS

[FUNC] + [SONG] opens the SONG EDIT menu.
 [FUNC] + [TRIG PARAMETERS] opens the QUANTIZE menu.
 [FUNC] + [SRC] opens the MACHINE menu.
 [FUNC] + [FLTR] opens the SETUP menu.
 [FUNC] + [AMP] opens the SEQUENCER menu.
 [FUNC] + [FX] opens the SEND FX pages.
 [FUNC] + [MOD] opens the MIXER pages.
 [FUNC] + [PAGE] opens the pattern/track PAGE SETUP menu.
 [FUNC] + [KEYBOARD] to go to keyboard setup menu.

SEQUENCER SETTINGS

[FUNC] + [TEMPO] to tap tempo.
 [LEFT/RIGHT] to nudge tempo (when sequencer is playing).
 [FUNC] + [LEFT/RIGHT] moves all trigs a whole step, left or right (when in GRID RECORDING mode).
 [TRIG] key (hold) + [LEFT/RIGHT], opens the MICRO TIMING menu and sets the micro timing for the trig (when in GRID RECORDING mode).
 [FUNC] + [UP]/[DOWN] (In the PAGE SETUP menu) sets the TRACK LENGTH in musical increments from 2/16 to 64/64.

SEQUENCER RECORDING

[RECORD] + [PLAY] starts LIVE RECORDING.
 [RECORD] + [STOP] activates STEP RECORDING.
 [RECORD] + double-press [PLAY] activates/deactivates QUANTIZE LIVE RECORDING.
 Hold [PAGE] and press [LEFT]/[RIGHT] to change sequencer page, or hold [PAGE] and press one of the lit [TRIGS] to jump to that page (when in GRID RECORDING mode).

MUTES

[FUNC] + [TRIG] keys mutes/unmutes one or several tracks.
 When in MUTE mode, press and hold [FUNC] + [TRIG] keys to prepare the track to be muted/unmuted. Releasing [FUNC] will perform the action.

MODES

[FUNC] + [TRK] enters GLOBAL MUTE mode.
 [FUNC] + double-press [TRK] enters PATTERN MUTE mode.
 [KEYBOARD] enters/exits KEYBOARD mode.
 [YES] + [PAGE] activates FILL mode for one pattern cycle. Pressing [PAGE] again deactivates FILL mode.

When not in GRID RECORDING mode, press and hold **[PAGE]** to activate FILL Mode for as long as **[PAGE]** is held.

Press and hold **[PAGE]** + **[YES]**, and then release **[PAGE]** before you release **[YES]** to latch FILL mode. Press **[PAGE]** again to unlatch FILL mode.

RESET PARAMETERS

Press **DATA ENTRY** knob + **[NO]** to reset the parameter to the default value.

[PARAMETER] key + **[PLAY]** to reset all the parameters in the selected parameter page to default values.

SAMPLE/SOUND/TRIG PREVIEW

[FUNC] + **[YES]** (In the SAMPLES menu) previews the highlighted sample.

[FUNC] + **[YES]** (In the SOUND BROWSER/SOUND MANAGER) previews the highlighted preset.

[TRIG] + **[YES]** (In GRID- and STEP RECORDING mode) previews the selected trig.

SONG MODE

[SONG] + **[TRIG 1-16]** to select song and enter SONG mode.

[FUNC] + **[SONG]** to open the SONG EDIT screen.

[SONG] + **[LEFT]** (when in SONG mode) to loop the currently playing row. Press **[SONG]** + **[LEFT]** again to stop looping the row and return to normal song playback.

[SONG] + **[UP]** (when in SONG mode) to move the song pointer up one row.

[SONG] + **[DOWN]** (when in SONG mode) to move the song pointer down one row.

Press **[SONG]** (when in SONG mode) twice to open the SONG EDIT screen.

[FUNC] + **[RECORD]** (when in the SONG EDIT screen) copies the selected row.

[FUNC] + **[STOP]** (when in the SONG EDIT screen) pastes a previously copied row to the selected row.

[FUNC] + **[PLAY]** (when in the SONG EDIT screen) resets the selected row to the pattern's default BPM, length, and mute state.

[FUNC] + **[DOWN]** (when in the SONG EDIT screen) adds a new row.

[FUNC] + **[UP]** (when in the SONG EDIT screen) deletes the selected row.

18. TECHNICAL INFORMATION

ELECTRICAL SPECIFICATIONS

Impedance balanced audio outputs

Main outputs level: +22 dBu peak

Output impedance: 440 Ω unbalanced

Headphones output

Headphones out level: +22 dBu peak

Output impedance: 55 Ω

Audio inputs

Input level: +19 dBu peak

Audio input impedance: 11 k Ω

Unit power consumption: 7 W typical

Recommended power supply: PSU-3c

12 V DC, 2A

HARDWARE

128 \times 64 pixel OLED screen

MIDI In/Out/Thru with DIN Sync out

2 \times 1/4" impedance balanced audio out jacks

2 \times 1/4" balanced audio in jacks

1 \times 1/4" stereo headphone jack

48 kHz, 24-bit D/A and A/D converters

Electrically isolated hi-speed USB 2.0 port

Power inlet: Center positive 5.5 \times 2.5 mm barrel jack,

12 V DC, 1 A

PHYSICAL SPECIFICATIONS

Sturdy steel casing

Dimensions: W 215 \times D 176 \times H 63 mm

(8.5" \times 6.9" \times 2.5") (including knobs and feet)

Weight: approximately 1.48 kg (3.25 lbs)

100 \times 100 mm VESA mounting holes. Use M4 screws with a max length of 7 mm.

Maximum recommended ambient operating

temperature: +40 $^{\circ}$ C (+104 $^{\circ}$ F)

19. CREDITS AND CONTACT INFORMATION

CREDITS

ELEKTRON CREW

Lennart Ahlstedt
Johannes Algelind
Magnus Almberg
Christian Alsing
Hans Alvarsson
Deva Andar
Nikolaj Andersson
Madeleine Antonsson
Anyere Bendrien
Andreas Brykt
Chloe Corely
Johan Damerau
Oscar Dragén
Magnus Forsell
Jennifer Giöbel
Birgitta Hedström
Mario Adriane Hernandez
Tomas Hjalmarsson
Thomas Jansson
Patrik Johansson
Christian Karlsson
George Kaplan
Åsa Larsson
Erik Liakhovets
Christer Lindström
Joel Lundberg
Johannes Mai
Enrique Martinez
Jimmy Myhrman
Viktor Nilsson
Jean Michel Pepin
Mattias Rickardsson
Patrik Rinvall
David Smallbone Tizard
Che Thomas
Jake Widgeon
Vladislav Zhukov

Erik Ångman

FACTORY LIBRARY SAMPLES

Adventure Kid (Kristoffer Ekstrand)
BlankFor.ms
Matt Davies
Lisa Nordström
Elin Piel
Johan Reivén
User Friendly
Craig Williams
The Elektron crew

FACTORY PATTERN DESIGN

The Elektron crew

CONTACT INFORMATION

ELEKTRON WEBSITE

<https://www.elektron.se>

OFFICE ADDRESS

Elektron Music Machines MAV AB
Banehagsliden 5
SE-414 51 Gothenburg
Sweden

APPENDIX A: MACHINES

A machine is a module within the Digitakt II with specific functionality. A machine can be switched out for another machine in the same category. For example different sample playback engines or a selection of filters. Every machine has a specific set of parameters tailored to give you the most relevant and useful sound-shaping possibilities for that particular machine. For more information, please see "5.3.1 AUDIO TRACKS AND MACHINES" on page 17.

A.1 ASSIGNING MACHINES TO THE ACTIVE TRACK

1. Press [FUNC] + [SRC] to open the MACHINE menu.
2. Use the [LEFT]/[RIGHT] keys to navigate to the desired machine category.
3. Use the [UP]/[DOWN] keys to select machine, and then press [YES] to assign the selected machine to the track.

The rest of this appendix lists the machine-specific parameters on the SRC and FLTR pages. The selected machine determines the parameters available. SRC page 2 contains the same parameters as on page 1 but with a view of the sample waveform. For more information, please see "11.4 SRC PAGE" on page 55.

A.2 SRC MACHINES

The SRC machines are sound engines that uses a particular subset of the functionality of the sample playback engine. In this section you also find the MIDI machine that lets you control external, MIDI equipped, gear. For more information, please see "5.3.2 MIDI TRACKS" on page 17. You can assign any SRC machine to any track.

A.2.1 ONESHOT

The Oneshot machine is the default machine and plays the sample linearly (forward, reversed, or looped). Press [SRC] to access this parameter page and to toggle between page 1 and page 2.

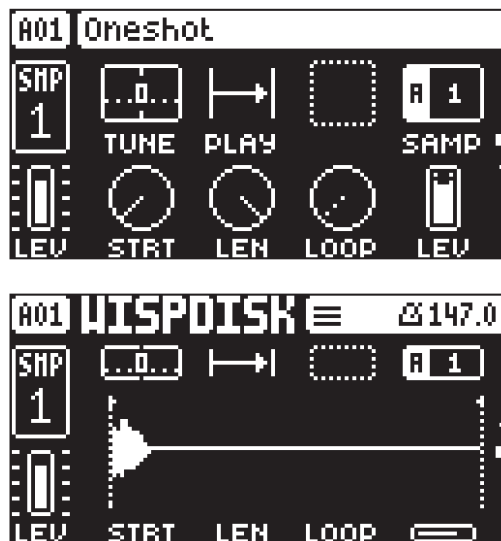

TUNE

Tune sets the pitch of the sample. The knob works in a bipolar fashion, and a value of 0 leaves the pitch unchanged. The range is +/- 5 octaves. Press and hold [FUNC], and then turn the *DATA ENTRY* knob to snap parameter values to full octaves. Press and turn the *DATA ENTRY* knob to snap parameter values to semitones.

PLAY

Play Mode sets the play mode of the sample. It controls how the sample will be played back when it is triggered.

The different modes are:

- **REVERSE** The sample will be played back in reverse once every time it is triggered.
- **REVERSE LOOP** The sample will loop continuously in reverse between Loop Position and Length. How long it will loop for is set with the LEN parameter on the TRIG page. This time is also constrained by the AMP page envelope parameters HLD and DEC.

- **FORWARD LOOP** The sample starts at the **STRT** position and will loop continuously between Loop Position and Length. How long it will loop for is set with the **LEN** parameter on the **TRIG** page. This time is also constrained by the **AMP** page envelope parameters **HLD** and **DEC**.
- **FORWARD** The sample will be played back once every time it is triggered.

SAMP

Sample Select. Here you can browse the list of up to 1016 samples loaded to the project, and assign them to the audio tracks. The first position, OFF, plays no sample. You must load a sample from the +Drive to the project before assigning it to a track. For more information, please see "13.3 ASSIGNING A SAMPLE TO A TRACK FROM THE +DRIVE" on page 69. You can apply parameter locks to the **SAMP** parameter and change the sample on any step of the sequencer, so called Sample locks. For more information, please see "10.8.1 PARAMETER LOCKS" on page 47.

STRT

Start sets the start position for playback of the sample.

LEN

Length sets the length of the playback of the sample. Start + Length effectively defines the end point of the portion of the sample that is played.

LOOP

Loop Pos sets the position in the sample to where playback will return to after reaching the Length Position (defined by **STRT + LEN**) of the sample if **PLAY MODE** is set to **FORWARD LOOP**. The sample is then looped between the end of **LEN** and **LOOP**. If **PLAY MODE** is set to **REVERSE LOOP**, the sample will start at **LEN** then move backwards to **LOOP** and then loop between of **LEN** and **LOOP**.

LEV

Sample Level sets the level of the sample.



If you press and hold [SRC], you can see the name of the currently loaded sample.

The **STRT**, **LEN**, and **LOOP** parameters.

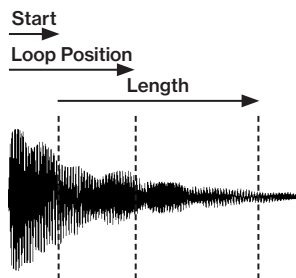

FORWARD LOOP play mode.

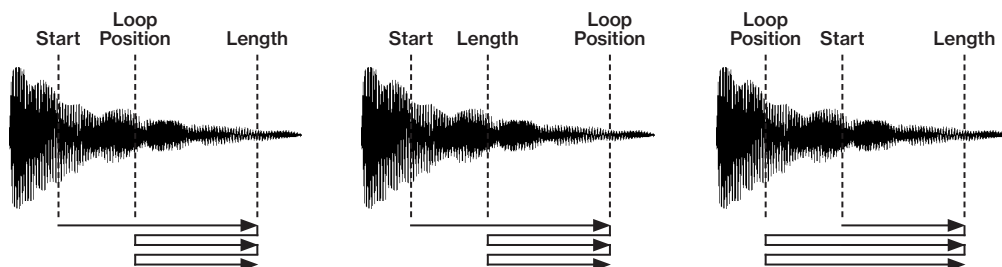

A.2.2 WERP

The Werp machine allows samples and loops to automatically stretch to the tempo of your project or pattern. The stretching is achieved through warping the audio. The sample is cut into small time segments and played consecutively aligned to the tempo.

Press [SRC] to access this parameter page and to toggle between page 1 and page 2.



TUNE

Tune sets the pitch of the sample. The knob works in a bipolar fashion, and a value of 0 leaves the pitch unchanged. The range is +/- 5 octaves. Press and hold [FUNC], and then turn the **DATA ENTRY** knob to snap parameter values to full octaves. Press and turn the **DATA ENTRY** knob to snap parameter values to semitones.

PLAY

Play Mode sets the play mode of the sample. It controls how the sample will be played back when triggered.

The different modes are:

- **REVERSE** The sample will be played back in reverse once every time it is triggered.
- **REVERSE LOOP** The sample will loop continuously in reverse between Loop Position and Length. How long it will loop for is set with the LEN parameter on the TRIG page. This time is also constrained by the AMP page envelope parameters **HLD** and **DEC**.
- **FORWARD LOOP** The sample starts at the **STRT** position and will loop continuously between Loop Position and Length. How long it will loop for is set with the LEN parameter on the TRIG page. This time is also constrained by the AMP page envelope parameters **HLD** and **DEC**.
- **FORWARD** The sample will be played back once every time it is triggered.

SAMP

Sample Select. Here you can browse the list of up to 1016 samples loaded to the project, and assign them to the audio tracks. The first position, OFF, plays no sample. You must load a sample from the +Drive to the project before assigning it to a track. For more information, please see "13.3 ASSIGNING A SAMPLE TO A TRACK FROM THE +DRIVE" on page 69. You can apply parameter locks to the SAMP parameter and change the sample on any step of the sequencer, so called Sample locks. For more information, please see "10.8.1 PARAMETER LOCKS" on page 47.

SEG

Segment Size determines the size of the segments, effectively setting the number of segments the sample is cut into. The higher the value, the larger/fewer segments. The cuts between the segments is made at the nearest zero amplitude crossing.

MODE

Segment Mode lets you select how each individual segment will be played back.

The different modes are:

- **REVERSE** Each segment will be played in reverse once.
- **REVERSE LOOP** Each segment will loop continuously in reverse until the next segment starts to play.
- **FORWARD LOOP** Each segment will loop continuously forward until the next segment starts to play.
- **FORWARD** Each segment will be played in forward mode once every time it is triggered.

BARS

Bars sets the total duration of the sample measured in bars and is relative to the set BPM.

LEV

Sample Level sets the level of the sample.

A.2.3 STRETCH

The Stretch machine allows samples and loops to automatically stretch to the tempo of your project or pattern by chopping the audio up into tiny grains and then fading between them.



TUNE

Tune sets the pitch of the sample. The knob works in a bipolar fashion, and a value of 0 leaves the pitch unchanged. The range is +/- 5 octaves. Press and hold **[FUNC]**, and then turn the **DATA ENTRY** knob to snap parameter values to full octaves. Press and turn the **DATA ENTRY** knob to snap parameter values to semitones.

PLAY

Play Mode sets the play mode of the sample. It controls how the sample will be played back when it is triggered.

The different modes are:

- **REVERSE** The sample will be played back in reverse once every time it is triggered.
- **REVERSE LOOP** The sample will loop continuously in reverse between Loop Position and Length. How long it will loop for is set with the LEN parameter on the TRIG page. This time is also constrained by the AMP page envelope parameters **HLD** and **DEC**.
- **FORWARD LOOP** The sample starts at the **STRT** position and will loop continuously between Loop Position and Length. How long it will loop for is set with the LEN parameter on the TRIG page. This time is also constrained by the AMP page envelope parameters **HLD** and **DEC**.
- **FORWARD** The sample will be played back once every time it is triggered.

SAMP

Sample Select. Here you can browse the list of up to 1016 samples loaded to the project, and assign them to the audio tracks. The first position, OFF, plays no sample. You must load a sample from the +Drive to the project before assigning it to a track. For more information, please see "13.3 ASSIGNING A SAMPLE TO A TRACK FROM THE +DRIVE" on page 69. You can apply parameter locks to the SAMP parameter and change the sample on any step of the sequencer, so called Sample locks. For more information, please see "10.8.1 PARAMETER LOCKS" on page 47.

STRT

Start sets the start position for playback of the sample.

LEN

Length sets the length of the playback of the sample. Start + Length effectively defines the end point of the portion of the sample that is played.

BARS

Bars sets the total duration of the sample measured in bars and is relative to the set BPM.

LEV

Sample Level sets the level of the sample.

A.2.4 REPITCH

The Repitch machine allows samples and loops to be automatically stretched to the tempo of your pattern. It achieves this by automatically applying repitching of the sample to match the target tempo. Press **[SRC]** to access this parameter page and to toggle between page 1 and page 2.

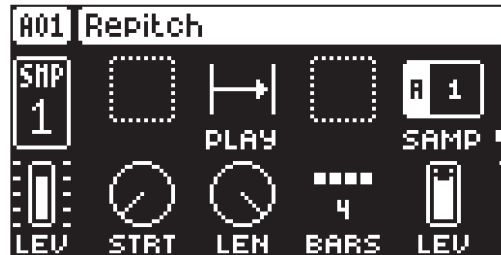

PLAY

Play Mode sets the play mode of the sample. It controls how the sample will be played back when it is triggered.

The different modes are:

- **REVERSE** The sample will be played back in reverse once every time it is triggered.
- **REVERSE LOOP** The sample will loop continuously in reverse between Loop Position and Length. How long it will loop for is set with the LEN parameter on the TRIG page. This time is also constrained by the AMP page envelope parameters **HLD** and **DEC**.
- **FORWARD LOOP** The sample starts at the **STRT** position and will loop continuously between Loop Position and Length. How long it will loop for is set with the LEN parameter on the TRIG page. This time is also constrained by the AMP page envelope parameters **HLD** and **DEC**.
- **FORWARD** The sample will be played back once every time it is triggered.

SAMP

Sample Select. Here you can browse the list of up to 1016 samples loaded to the project, and assign them to the audio tracks. The first position, OFF, plays no sample. You must load a sample from the +Drive to the project before assigning it to a track. For more information, please see "13.3 ASSIGNING A SAMPLE TO A TRACK FROM THE +DRIVE" on page 69. You can apply parameter locks to the SAMP parameter and change the sample on any step of the sequencer, so called Sample locks. For more information, please see "10.8.1 PARAMETER LOCKS" on page 47.

STRT

Start sets the start position for playback of the sample.

LEN

Length sets the length of the playback of the sample. Start + Length effectively defines the end point of the portion of the sample that is played.

BARS

Bars sets the total duration of the sample measured in bars and is relative to the set BPM.

LEV

Sample Level sets the level of the sample.

A.2.5 GRID

The Grid machine allows samples to be automatically sliced into similarly-sized segments (slices) and triggered individually. Press [SRC] to access this parameter page and to toggle between page 1 and page 2.



TUNE

Tune sets the pitch of the sample. The knob works in a bipolar fashion, and a value of 0 leaves the

pitch unchanged. The range is +/- 5 octaves. Press and hold **[FUNC]**, and then turn the **DATA ENTRY** knob to snap parameter values to full octaves. Press and turn the **DATA ENTRY** knob to snap parameter values to semitones.

PLAY

Play Mode sets the play mode of the sample. It controls how the sample will be played back when it is triggered.

The different modes are:

- **REVERSE** The sample will be played back in reverse once every time it is triggered.
- **REVERSE LOOP** The sample will loop continuously in reverse between Loop Position and Length. How long it will loop for is set with the LEN parameter on the TRIG page. This time is also constrained by the AMP page envelope parameters **HLD** and **DEC**.
- **FORWARD LOOP** The sample starts at the **STRT** position and will loop continuously between Loop Position and Length. How long it will loop for is set with the LEN parameter on the TRIG page. This time is also constrained by the AMP page envelope parameters **HLD** and **DEC**.
- **FORWARD** The sample will be played back once every time it is triggered.

SAMP

Sample Select. Here you can browse the list of up to 1016 samples loaded to the project, and assign them to the audio tracks. The first position, OFF, plays no sample. You must load a sample from the +Drive to the project before assigning it to a track. For more information, please see "13.3 ASSIGNING A SAMPLE TO A TRACK FROM THE +DRIVE" on page 69. You can apply parameter locks to the SAMP parameter and change the sample on any step of the sequencer, so called Sample locks. For more information, please see "10.8.1 PARAMETER LOCKS" on page 47.

SLICE

Slice Select lets you set which slice to play. If set to NOTE you can use the TRIG keys in KEYBOARD mode or incoming MIDI note data to determine which slice to play.



All the settings in the **KEYBOARD SETUP** menu are ignored for a track that uses the Grid machine and when **SLICE** is set to **NOTE**. Instead slices plays from C1 and upwards, wrapping around after the last slice. The first slice is highlighted with a blue **[TRIG]** key in **KEYBOARD** mode.

LEN

Slice Length sets how many slices that will play consecutively.

GRID

Slice Grid sets the number of slices the sample is cut in. The slices are evenly spread out over the whole length of the sample. The cuts between the slices are done at the nearest zero amplitude crossing.

LEV

Sample Level sets the level of the sample.



By using parameter locks of the **SLICE** parameter, you can set which slice the sequencer will play on a trig. But you can also automatically allocate slices to already placed trigs. There are two different choices for how they can be allocated.

LINEAR LOCKS The slices are allocated linearly to the trigs, starting with the first slice on the first placed trig.

RANDOM LOCKS The slices are allocated randomly to the trigs.

1. Select the **GRID** machine for the active track.
2. Place trigs on the sequencer.
3. On the **SRC** page, press **[YES]** to open the **ALLOCATE SLICE** menu
4. Use **[UP]**/**[DOWN]** to select **CREATE LINEAR LOCKS** or **CREATE RANDOM LOCKS**
5. Press **[YES]** to create locks to allocate slices. With **CREATE RANDOM LOCKS** selected, the slice allocation will randomize every time you press **[YES]**.
6. Press **[NO]** to exit the menu.

A.2.6 MIDI

The parameters for the MIDI machine are split over the **TRIG**, **SRC**, **FLTR** and **AMP PARAMETER** pages. The **FX** page contains no parameters. The **MOD** pages are the same as for audio tracks, but there are two LFOs available for MIDI tracks.

TRIG PAGE 1

Set the actions for when a note is triggered. Change settings using the **DATA ENTRY** knobs. These general settings affect note trigs placed in the sequencer.

Press **[TRIG PARAMETERS]** to access this parameter page.

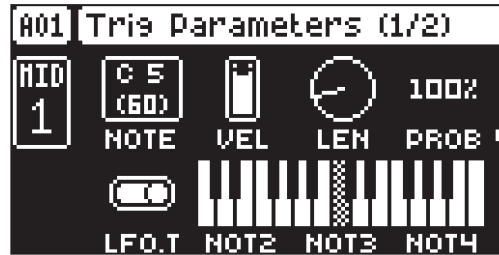

NOTE

Trig Note sets the pitch of the note when triggered. When in **LIVE RECORDING** mode and playing in **KEYBOARD** mode, the pitch of the **[TRIG]** keys played will override this setting. Press and turn **DATA ENTRY** knob **A** to select only note values that exist in the scale set by **KB SCALE**. For more information, please see "8.5.2 KEYBOARD SETUP MENU" on page 25.

VEL

Trig Velocity sets the velocity of the sequencer's note trigs.

LEN

Trig Length sets the length of the note trig. In **LIVE RECORDING** mode, the duration of pressing the **[TRIG]** keys overrides this general setting.

PROB

Trig Probability sets the probability that the trigs on the track plays or not. The probability outcome is re-evaluated every time a trig is set to play. The default setting is 100%, meaning that all the trigs on the track plays every time. This parameter can be parameter locked which lets you give separate trigs their own probability.

LFO.T

LFO Trig controls if the LFO will be triggered or not.

NOT2-NOT4

Note 2-4 will add more notes, offset from the root note by the selected values, to a note trig. This makes it possible for a MIDI track to send out chords that consists of up to 4 notes. If the root note is changed the offset notes will transpose accordingly. A value of 0 will remove the offset note.

TRIG PAGE 2

Here you set the trig conditions. Change settings using the **DATA ENTRY** knobs. These general settings all affect note trigs placed in the sequencer.

Press **[TRIG PARAMETERS]** twice to access this parameter page.



FILL

Fill is a separate trig condition that determines if a trig is active (plays) or not depending on if the device is in FILL mode or not. For more information, please see "10.8.4 FILL MODE" on page 49, and "10.7.3 TRIG CONDITIONS AND CONDITIONAL LOCKS" on page 48.

ON A trig with FILL set to ON, is active (plays the trig) when FILL mode is active.

OFF A trig with FILL set to OFF is active when FILL mode is not active.

COND

(Trig Condition) when you add a conditional lock. **COND** sets the Trig Condition with which a set of conditional rules can be applied to any trig, using a parameter lock. For more information, please see "10.7.3 TRIG CONDITIONS AND CONDITIONAL LOCKS" on page 48.

SRC page

Here you can set the MIDI channel that the MIDI machine should use to send data. Bank and program change values are also set here, together with a few standard CC parameters. The default value of the parameters on this page is OFF, meaning they are disabled and do not send out any data. Press and hold **[FUNC]** and then press the **DATA ENTRY** knobs to enable them. You can then use the **DATA ENTRY** knobs to set the parameter values as usual. Disable the parameters again by repeating the activation procedure.

Press **[SRC]** once to access this parameter page.



CHAN (Channe) sets the MIDI channel the track sends MIDI data to. If you set this parameter to OFF, it turns the MIDI track off. Please note that this parameter cannot be parameter locked. (OFF, 1-16)

BANK (Bank) sends a bank change message on CC 0 MSB.

SBNK (Sub Bank) sends a bank change message on CC 32 LSB.

PROG (Program Change) sends a Program Change message.

PB (Pitch Bend) controls the pitch bend data sent on the MIDI track.

AT (Aftertouch) controls the aftertouch data sent on the MIDI track.

MW (Mod Wheel) controls the modulation wheel data sent on the MIDI track.

BC (Breath Controller) controls the breath control data sent on the MIDI track.

FLTR PAGE 1

Here you can set the values of the first eight assignable CC commands. The default value of the parameters on this page is OFF, meaning they are disabled and do not send out any data. Press and hold **[FUNC]** and then press the **DATA ENTRY** knobs to enable them. You can then use the **DATA ENTRY** knobs to set the parameter values as usual. Disable the parameters again by repeating the enabling procedure.

Press **[FLTR]** to access this parameter page.

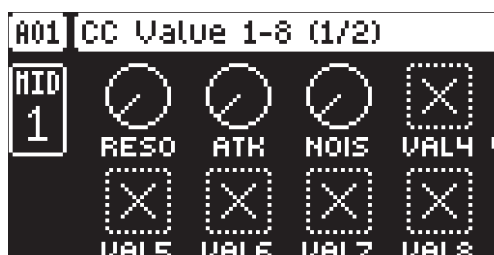

VAL1-VAL8 (CC 1-8 Value) controls the values that the CC commands send. You specify the CC commands themselves on FLTR page 2. These parameters default value is OFF. Press **[FUNC]** + **DATA ENTRY** knobs to activate the parameters and then turn the **DATA ENTRY** knobs to set a value.



Here you also have the possibility to name the parameter whose value you control. Press and hold **[FUNC]** and then press and hold any **DATA ENTRY** knob to access the naming screen. For more information, please see "6.5 THE NAMING SCREEN" on page 19.

FLTR PAGE 2

Here you select the first eight CC commands whose values you set with the parameters on the FLTR page 1. Press the corresponding knob or **[YES]** to activate the CC command change.

Press **[FLTR]** twice to access this parameter page.



SEL1-SEL8 (CC 1-8 Select) specifies the CC commands whose values you control controlled by the parameters on the AMP PAGE 1 (CC VALUE) page. The selectable commands are the standard MIDI Control Change Messages.



You can specify the CC command for the SEL parameters by sending the CC value from the external MIDI equipped device you want to control.

1. On FLTR PAGE 2 or AMP PAGE 2 press and hold **[FUNC]** + **DATA ENTRY** knob A-H.
2. When the popup screen MIDI LEARN appears, and the parameter starts flashing, you can send a MIDI CC value on the active track's MIDI channel (set in the SETTINGS > MIDI CONFIG > CHANNELS menu) or on the auto channel.
3. The popup disappears and the parameter stops flashing when the sent CC value is received and configured on the selected SEL parameter. You can cancel MIDI learn by pressing **[NO]** twice.

AMP PAGE 1

Here you can set the values for eight additional assignable CC commands.

VAL9-VAL16 (CC 9-16 Value) controls the values that the CC commands send. You specify the CC commands themselves on AMP page 2. These parameters default value is OFF. Press **[FUNC]** + **DATA ENTRY** knobs to activate the parameters and then turn the **DATA ENTRY** knobs to set a value.

Press **[AMP]** to access this parameter page.

AMP PAGE 2

Here you select the eight additional CC commands whose values you set with the parameters on AMP page 1. Press the corresponding knob or **[YES]** to activate the parameter change.

SEL9-SEL16 (CC 9-16 Select) specifies the CC commands whose values you control controlled by the parameters on the AMP page 1 (CC VALUE) page. The selectable commands are the standard MIDI Control Change Messages.

Press **[AMP]** twice to access this parameter page.



Please note that the MIDI machine has two LFOs.

A.3 FLTR MACHINES

The FLTR machines are a collection of different filters and EQ.

A.3.1 MULTI-MODE

This filter lets you morph from a Lowpass to Bandpass to Highpass filter



ATK

Attack Time sets the length of the attack phase of the filter envelope.

DEC

Decay Time sets the length of the decay phase of the filter envelope.

SUS

Sustain Level sets the sustain level of the filter envelope.

REL

Release Time sets the length of the release phase of the filter envelope.

FREQ

Frequency sets the cutoff frequency of the multi-mode filter and the center frequency of the EQ.

RESO/GAIN

Resonance sets the resonance behavior of the filter. Resonance introduces a peak in the spectrum at the cutoff frequency. Gain sets the amount of boost/cut around the center frequency of the EQ.

TYPE

Type morphs the multimode filter from Lowpass to Bandpass to Highpass

ENV

Env. Depth sets the amount of cutoff frequency modulation from the filter envelope. The knob is bipolar, both negative and positive modulation depths are available.

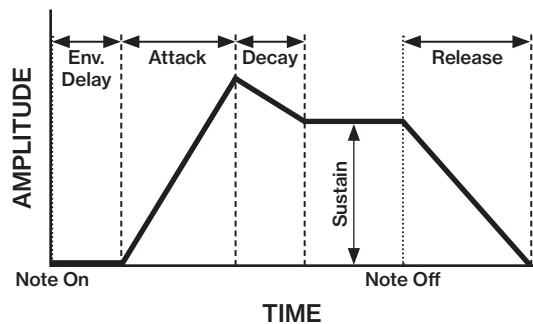

A.3.2 LOWPASS 4

This is a 4-pole low-pass filter with a 24 dB slope.

**ATK**

Attack Time sets the length of the attack phase of the filter envelope.

DEC

Decay Time sets the length of the decay phase of the filter envelope.

SUS

Sustain Level sets the sustain level of the filter envelope.

REL

Release Time sets the length of the release phase of the filter envelope.

FREQ

Frequency sets the cutoff frequency of the filter.

RESO

Resonance sets the resonance behavior of the filter. Resonance introduces a peak in the spectrum at the cutoff frequency.

ENV

Env. Depth sets the amount of cutoff frequency modulation from the filter envelope. The knob is bipolar, both negative and positive modulation depths are available.

A.3.3 EQ

This machine is a parametric Equalizer.

**ATK**

Attack Time sets the length of the attack phase of the EQ envelope.

DEC

Decay Time sets the length of the decay phase of the EQ envelope.

SUS

Sustain Level sets the sustain level of the EQ envelope.

REL

Release Time sets the length of the release phase of the EQ envelope.

FREQ

Frequency sets the center frequency of the EQ.

GAIN

Gain sets the amount of boost/cut around the center frequency of the EQ.

Q

Q lets you select the bandwidth of the frequency range that the EQ affects. The higher the Q value, the narrower the bandwidth. A broad bandwidth boosts or cuts a larger band of frequencies than a narrow.

ENV

Env. Depth sets the amount of cutoff frequency modulation from the filter envelope. The knob is bipolar, both negative and positive modulation depths are available.



The parametric EQ is used to boost desired frequencies or to remove unwanted frequencies of the sound.

A.3.4 COMB

The comb filter introduces metallic sounding, pitch tuned, resonant overtones.



ATK

Attack Time sets the length of the attack phase of the filter envelope.

DEC

Decay Time sets the length of the decay phase of the filter envelope.

SUS

Sustain Level sets the sustain level of the filter envelope.

REL

Release Time sets the length of the release phase of the filter envelope.

FREQ

Frequency sets the resonant frequencies of the comb filter.

FDBK

Feedback sets the gain of the feedback signal.

LPF

Low Pass Filter sets the cutoff frequency of the low pass filter that is implemented in the feedback signal.

ENV

Env. Depth sets the amount of cutoff frequency modulation from the filter envelope. The knob is bipolar, both negative and positive modulation depths are available.

A.3.5 LEGACY

The legacy filter is inspired by the filter from the first Digitakt and is a filter that is switchable between Lowpass and Highpass.



ATK

Attack Time sets the length of the attack phase of the filter envelope.

DEC

Decay Time sets the length of the decay phase of the filter envelope.

SUS

Sustain Level sets the sustain level of the filter envelope.

REL

Release Time sets the length of the release phase of the filter envelope.

FREQ

Frequency sets the cutoff frequency of the filter.

RESO

Resonance sets the resonance behavior of the filter. Resonance introduces a peak in the spectrum at the cutoff frequency.

TYPE

Filter Type lets you select between a Lowpass or Highpass filter, both 2-pole, 12 dB.

ENV

Env. Depth sets the amount of cutoff frequency modulation from the filter envelope. The knob is bipolar, both negative and positive modulation depths are available.

APPENDIX B: MIDI

This appendix lists the CC and NRPN specification for the Digitakt II.

B.1 TRACK PARAMETERS

TRACK				
Parameter	CC MSB	CC LSB	NRPN MSB	NRPN LSB
Mute	94		1	101
Track level	95		1	100

B.2 TRIG PARAMETERS

TRIG PARAMETERS				
Parameter	CC MSB	CC LSB	NRPN MSB	NRPN LSB
Note	3		3	0
Velocity	4		3	1
Length	5		3	2
Filter Trig	13			
LFO Trig	14			
Portamento Time	9		3	7
Portamento On/Off	65		3	8

B.3 SOURCE PARAMETERS

SOURCE				
Parameter	CC MSB	CC LSB	NRPN MSB	NRPN LSB
Tune	16		1	0
Play Mode	17		1	1
Sample Select			1	3
Data entry knob E (machine dependent)	20		1	4
Data entry knob F (machine dependent)	21		1	5
Data entry knob G (machine dependent)	22		1	6
Sample Level	23		1	7

B.4 FILTER PARAMETERS

FILTER				
Parameter	CC MSB	CC LSB	NRPN MSB	NRPN LSB
Filter Frequency	74		1	20
Data entry knob F (machine dependent)	75		1	21
Data entry knob G (machine dependent)	76		1	22
Env. Depth	77		1	23
Attack Time	70		1	16
Decay Time	71		1	17
Sustain Level	72		1	18
Release Time	73		1	19
Env. Delay	91		1	23
Key Tracking	92		1	69
Base	84		1	51

FILTER				
Parameter	CC MSB	CC LSB	NRPN MSB	NRPN LSB
Width	85		1	52
Env. Reset	111		1	68

B.5 AMP PARAMETERS

AMP				
Parameter	CC MSB	CC LSB	NRPN MSB	NRPN LSB
Attack Time	79		1	30
Hold Time	80		1	31
Decay Time	81		1	32
Sustain Level	82		1	33
Release Time	83		1	34
Env. Reset	88		1	41
Mode	87		1	40
Pan	90		1	38
Volume	89		1	39

B.6 EUCLIDEAN SEQUENCER PARAMETERS

AMP				
Parameter	CC MSB	CC LSB	NRPN MSB	NRPN LSB
Pulse Generator 1			3	8
Pulse Generator 2			3	9
Euclidean Mode On/Off			3	14
Rotation Generator 1			3	11
Rotation Generator 2			3	12
Track Rotation			3	13
Boolean Operator			3	10

B.7 FX PARAMETERS

AMP				
Parameter	CC MSB	CC LSB	NRPN MSB	NRPN LSB
Bit Reduction	54			
Overdrive	57			
Sample Rate Reduction	55			
SRR Routing	56			
Delay Send	84		1	36
Reverb Send	85		1	37
Chorus Send	86		1	38

B.8 MOD PARAMETERS

Note that the LFO 1/2/3 speed and depth are high-resolution parameters, with CC LSB values.

LFO 1				
Parameter	CC MSB	CC LSB	NRPN MSB	NRPN LSB
Speed	102	58	1	42
Multiplier	103		1	43
Fade In/Out	104		1	44

LFO 1				
Parameter	CC MSB	CC LSB	NRPN MSB	NRPN LSB
Destination	105		1	45
Waveform	106		1	46
Start Phase	107		1	47
Trig Mode	108		1	48
Depth	109	59	1	49

LFO 2				
Parameter	CC MSB	CC LSB	NRPN MSB	NRPN LSB
Speed	112	60	1	50
Multiplier	113		1	51
Fade In/Out	114		1	52
Destination	115		1	53
Waveform	116		1	54
Start Phase	117		1	55
Trig Mode	118		1	56
Depth	119	61	1	57

LFO 3				
Parameter	CC MSB	CC LSB	NRPN MSB	NRPN LSB
Speed	78	62	1	58
Multiplier	52		1	59
Fade In/Out	53		1	60
Destination	28		1	61
Waveform	29		1	62
Start Phase	30		1	70
Trig Mode	31		1	71
Depth	86	63	1	72

B.9 SEND FX PARAMETERS

DELAY				
Parameter	CC MSB	CC LSB	NRPN MSB	NRPN LSB
Delay Time	21		2	0
Pingpong	22		2	1
Stereo Width	23		2	2
Feedback	24		2	3
Highpass Filter	25		2	4
Lowpass Filter	26		2	5
Reverb Send	27		2	6
Mix Volume	28		2	7

REVERB				
Parameter	CC MSB	CC LSB	NRPN MSB	NRPN LSB
Predelay	29		2	8
Decay Time	30		2	9
Shelving Freq	31		2	10

REVERB				
Parameter	CC MSB	CC LSB	NRPN MSB	NRPN LSB
Shelving Gain	89		2	11
Highpass Filter	90		2	12
Lowpass Filter	91		2	13
Mix Volume	92		2	15

CHORUS				
Parameter	CC MSB	CC LSB	NRPN MSB	NRPN LSB
Depth	16		2	0
Speed	9		2	1
High Pass Filter	70		2	2
Width	71		2	3
Delay Send	12		2	4
Reverb Send	13		2	5
Mix Volume	14		2	6

B.10 MIXER PARAMETERS

COMPRESSOR				
Parameter	CC MSB	CC LSB	NRPN MSB	NRPN LSB
Threshold	111		2	16
Attack Time	112		2	17
Release Time	113		2	18
Makeup Gain	114		2	19
Pattern Volume	119		2	24
Ratio	115		2	20
Sidechain Source	116		2	21
Sidechain Filter	117		2	22
Dry/Wet Mix	118		2	23

EXTERNAL IN MIXER				
Parameter	CC MSB	CC LSB	NRPN MSB	NRPN LSB
Dual Mono	82		2	40
Input L Level	72		2	30
Input L Pan	74		2	32
Input R Level	72		2	31
Input R Pan	75		2	33
Input L Delay Send	78		2	36
Input R Delay Send	79		2	35
Input L Reverb Send	80		2	38
Input R Reverb Send	81		2	39
Input L Chorus Send	76		2	34
Input R Chorus Send	77		2	35
Input L R Level	72		2	30
Input L R Balance	74		2	32
Input L R Delay Send	78		2	36

EXTERNAL IN MIXER				
Parameter	CC MSB	CC LSB	NRPN MSB	NRPN LSB
Input L R Reverb Send	80		2	38
Input L R Chorus Send	76		2	34

B.8 VAL PARAMETERS

These are the CC VAL parameters on the [FLTR] and [AMP] pages for MIDI tracks.

CC VAL				
Parameter	CC MSB	CC LSB	NRPN MSB	NRPN LSB
VAL1	70		1	16
VAL2	71		1	17
VAL3	72		1	18
VAL4	73		1	19
VAL5	74		1	20
VAL6	75		1	21
VAL7	76		1	22
VAL8	77		1	23
VAL9			1	60
VAL10			1	61
VAL11			1	62
VAL12			1	63
VAL13			1	64
VAL14			1	65
VAL15			1	66
VAL16			1	67

B.9 MISC PARAMETERS

MISC				
Parameter	CC MSB	CC LSB	NRPN MSB	NRPN LSB
Pattern Mute	110		1	104
Sample Slot	9		1	8
Sample Bank	24		1	9
Master Overdrive	17		2	37

APPENDIX C: LFO MODULATION DESTINATIONS

The following are the modulation destinations for the Digitakt II's LFOs:

AUDIO TRACKS

META: None

LFO1: Speed (Only available for LFO2/3)

LFO1: Multiplier (Only available for LFO2/3)

LFO1: Fade In/Out (Only available for LFO2/3)

LFO1: Waveform (Only available for LFO2/3)

LFO1: Start Phase (Only available for LFO2/3)

LFO1: Trig Mode (Only available for LFO2/3)

LFO1: Depth (Only available for LFO2/3)

LFO2: Speed (Only available for LFO3)

LFO2: Multiplier (Only available for LFO3)

LFO2: Fade In/Out (Only available for LFO3)

LFO2: Waveform (Only available for LFO3)

LFO2: Start Phase (Only available for LFO3)

LFO2: Trig Mode (Only available for LFO3)

LFO2: Depth (Only available for LFO3)

SRC: Tune

SRC: Play Mode

SRC: Sample Slot

SRC: Data entry knob E (machine dependent)

SRC: Data entry knob F (machine dependent)

SRC: Data entry knob G (machine dependent)

SRC: Level

FILTER: (machine dependent parameters)

FILTER: Envelope Depth

FILTER: Env. Delay

FILTER: Attack Time

FILTER: Decay Time

FILTER: Sustain Level

FILTER: Release Time

FILTER: Env. Reset

FILTER: Base

FILTER: Width

FILTER: Key Tracking

AMP: Attack Time

AMP: Hold Time

AMP: Decay Time

AMP: Sustain Level

AMP: Release Time

AMP: Pan

AMP: Volume

FX: Delay Send

FX: Reverb Send

FX: Chorus Send

FX: Bit Reduction

FX: SRR

FX: SRR Routing

FX: Overdrive

MIDI TRACKS

META: None

LFO1: Speed (Only available for LFO2)

LFO1: Multiplier (Only available for LFO2)

LFO1: Fade In/Out (Only available for LFO2)

LFO1: Waveform (Only available for LFO2)

LFO1: Start Phase (Only available for LFO2)

LFO1: Trig Mode (Only available for LFO2)

LFO1: Depth (Only available for LFO2)

SRC: Pitch Bend

SRC: Aftertouch

SRC: Mod Wheel

SRC: Breath Controller

CC: CC1-16 Values

APPENDIX D: KEYBOARD SCALES

The following are the selectable scales for the KEYBOARD mode. For more information, please see: "8.5.1 KEYBOARD MODE" on page 25,

- CHROMATIC
- IONIAN (MAJOR)
- DORIAN
- PHRYGIAN
- LYDIAN
- MIXOLYDIAN
- AEOLIAN (MINOR)
- LOCRIAN
- PENTATONIC MINOR
- PENTATONIC MAJOR
- MELODIC MINOR
- HARMONIC MINOR
- WHOLE TONE
- BLUES
- COMBO MINOR
- PERSIAN
- IWATO
- IN-SEN
- HIRAJOSHI
- PELOG
- PHRYGIAN DOMINANT
- WHOLE-HALF DIMINISHED
- HALF-WHOLE DIMINISHED
- SPANISH
- MAJOR LOCRIAN
- SUPER LOCRIAN
- DORIAN *b*2
- LYDIAN AUGMENTED
- LYDIAN DOMINANT
- DOUBLE HARMONIC MAJOR
- LYDIAN #2 #6
- ULTRAPHRYGIAN
- HUNGARIAN MINOR
- ORIENTAL
- IONIAN #2 #5
- LOCRIAN *bb*3 *bb*7

INDEX

+DRIVE 16, 29

A

AUDIO ROUTING

Global 79

AUDIO TRACK PARAMETERS 53

Amp 55

Filter 55

LFO 57

Source 55

Trig 53, 54

B

BACKUP 20

BREATH CONTROLLER 39

C

CHAINS 40

CHORUS 63

CHROMATIC MODE 25

CLASS COMPLIANT 20

COMPRESSOR 63

CONDITIONAL LOCKS 48

CONNECTORS 14

CONTROL ALL 19

Configuration 37

COPY, PASTE AND CLEAR 49

CREDITS AND CONTACT INFORMATION 90

D

DATA STRUCTURE 16

Patterns 16

Project 16

Samples 17

Sounds 16

DELAY 61

E

EARLY STARTUP MENU 83

EUCLIDEAN SEQUENCER 44

F

FACTORY RESET 83

FILL MODE 49

FILTER 55

FX PARAMETERS 61

Chorus 63

Delay 61

Reverb 62

G

GRID RECORDING MODE 42

K

KEYBOARD SCALES 110

KEY COMBINATIONS 86

KITS 29

L

LED INTENSITY 81

LEGATO 38

LFO 57, 58, 59

Modulation destinations 109

LINEAR LOCKS 96

M

MACHINES 17, 91

Assigning to track 91

Oneshot 91, 100

Repitch 94

Slice 95

Werp 92

METRONOME 23

MICRO TIMING 45

MIDI CC & NRPN 104

MIDI CONFIG 75, 76

MIDI LEARN 99

MIDI TRACKS 17

Parameters 97

MIXER 65, 66

MUTE MODE 26

N

NAMING SCREEN 19

O

OS UPGRADE 82

P

PANEL LAYOUT 12

PARAMETER LOCKS 47

PATTERNS

Grid recording mode 42

Live recording mode 42

Parameter locks 47

Pattern control 40

Selecting a pattern 40

Trig modes 27

Trig Types 41

PATTERNS AND SOUNDS

Sound Browser 36

PATTERNS, KITS, SOUNDS, AND SAMPLES 29

Assigning a sample 36

Editing a sound 35

Playing a sound 35

Sound Manager 30

PERFORM KIT MODE 52

PORTAMENTO 37

On/Off 55

PRESET BROWSER 30

PRESET LOCKS 47**PRESET MANAGER 30****PRESETS 29**

- Audio track parameters 53
- Editing a preset 35
- Playing a preset 35
- Purging 35
- Saving a preset 35

PROJECT MANAGER 74**PROJECTS 74**

- Load 74
- Project Manager 74
- Save 74
- Write protection 74

PURGE (REMOVE UNUSED)

- All 74
- Kits 35
- Samples 73

Q**QUANTIZATION 45****QUICK SCROLLING 19****QUICK START 22****R****RANDOM LOCKS 96****RETRIGS 45, 54****REVERB 62****S****SAFETY AND MAINTENANCE 3****SAMPLES**

- Create a new destination directory 73
- Loading 71
- Moving 72
- Removing unused 73
- Renaming 72
- Replacing 72
- Transferring from computer 73
- Unloading 72

SAMPLING 68

- Assigning a sample from +Drive 69
- Sample playback 70
- Sampling audio 23, 69

SCALE 26**SCALES 110****SCALE SETUP**

- Length per pattern mode 45
- Length per track mode 46

SCREEN SAVER 18**SEQUENCER 40**

- Conditional locks 48
- Editing a pattern 41
- Parameter locks 47
- Pattern control 40
- Retrig Menu 45

Scale Menu 45

Selecting a pattern 40

Trig menu 44

Trig parameters page 45

SEQUENCER RECORDING MODES

Grid recording mode 42

Live recording mode 42

Step recording mode 43

SETTINGS 74

MIDI config 75, 76

Project 74

System 80, 81

SETUP EXAMPLES 20, 84

Controlling a synthesizer using the MIDI tracks 85

Digitakt with a monophonic bass machine 84

Sampling from a smart phone 84

SONG MODE 50, 52**SOUND ARCHITECTURE 15****SOUND BROWSER 36****SOUND MENU 36****SOUND SETUP MENU 37**

Pitch bend 38

SWING 23**SYSEX DUMP 78****T****TECHNICAL INFORMATION 89****TEMPO 22****TEMPORARY SAVE AND RELOAD 49****TRIG MENU 44****TRIG MODE 27****TRIG PARAMETERS PAGE 45****TRIGS 41**

Lock trigs 41

Note trigs 41

Parameter locks 47

Sound lock 47

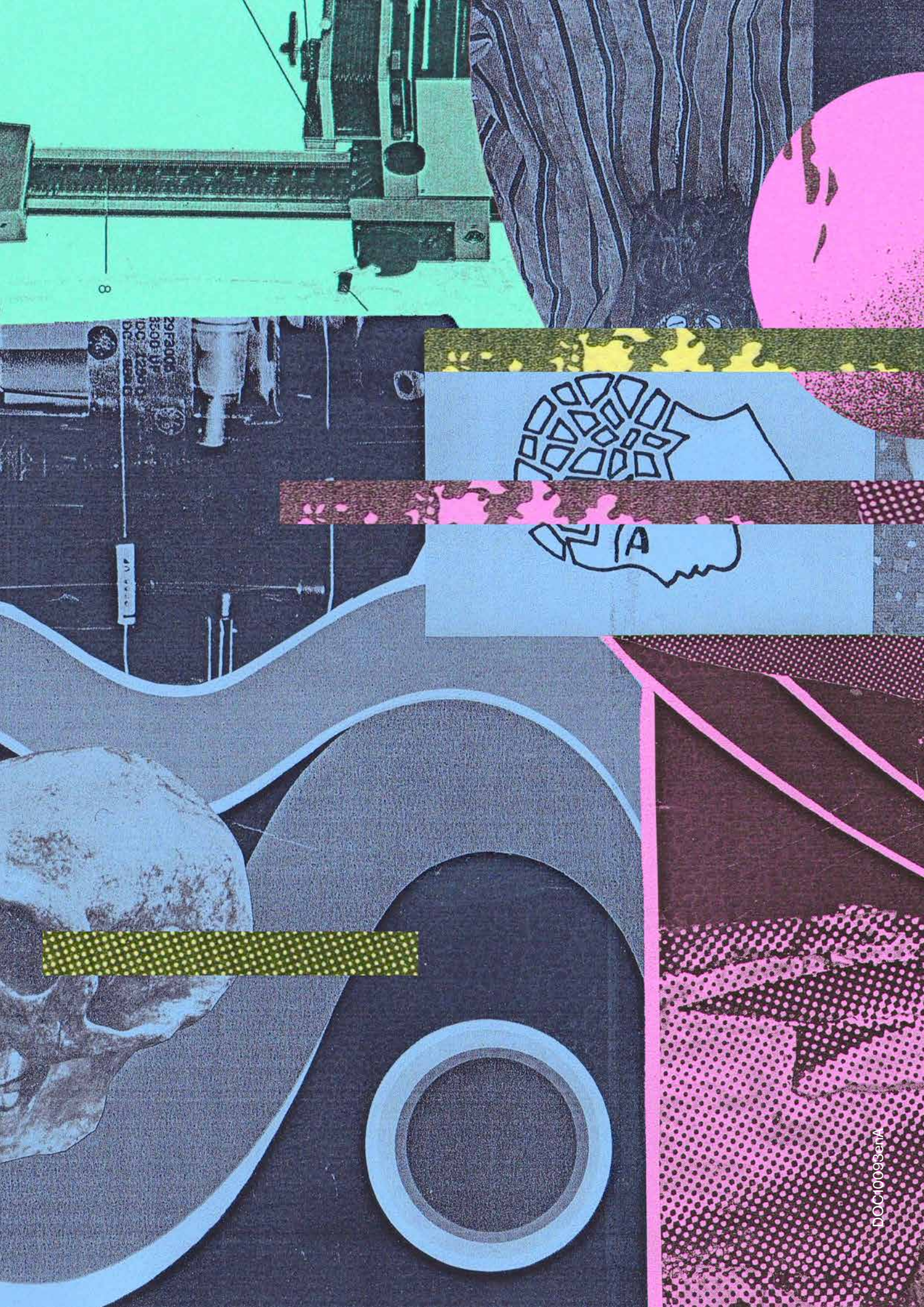

8

29fa00d5
3500 D7
10C 42558
DC 8888

AV 2222

DOC10093enA